

Catalogo generale

Main Catalogue

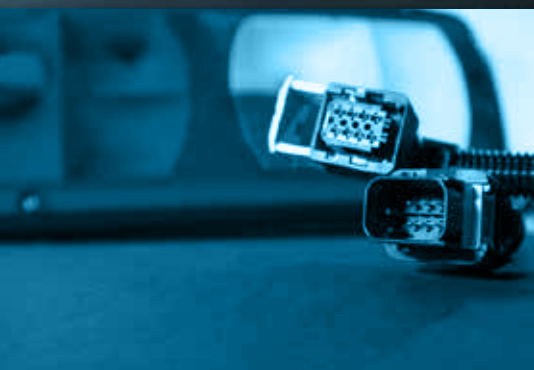

Cablaggi entro 24 ore ex works Cable sets in 24 hours ex works





Per garantire la efficienza dei costi, il rispetto delle norme internazionali e della qualità è opportuno di coinvolgere il fornitore di sistema fin dal inizio del progetto. Su richiesta prendiamo cura del Vs. progetto, dallo sviluppo alla produzione! Nella nostra produzione di Kirch-

dorf an der Krems confezioniamo cablaggi singoli e di serie nel pieno rispetto delle norme internazionali e ad alta qualità. Grazie alla nostra flessibilità siamo in grado di realizzare cablaggi di preserie oppure modificare la serie corrente in breve tempo. Ai nostri clienti offriamo anche la

gamma completa dei materiali. Per perfezionare la relazione tra produttore e subfornitore, offriamo la completa programma di materiale del nostro vasto di campo d'attività anche per la vendite.

To guarantee cost efficiency, compliance of international norms and quality standards it is useful to integrate the system supplier in a very early stage of the project. Definitive environmental awareness, cost reduction and optimisation of assembly at simultaneously increase of quality are the strength of our team. We take care for your project

according to your needs from concept to production. In our manufacturing base in Kirchdorf we make serial cable harnesses and special harnesses with individual marking according to international standards and norms. Due to the flexibility of the company we can realise start-ups of production and changes in

running serial production very quick. Of course we are using most modern machines and Automation. Use our contacts and experience to various international single part suppliers. To perfect the relation Manufacturer – Supplier we offer the complete material program of our wide business area also for sale.



Spedizione standard

Austria: 1-2 giorni
Europa: 2-3 giorni

Spedizione espresso

Austria e Germania:
Recapito garantito entro le 12:00 il giorno successivo. Consegna sabato possibile

Standard shipping

Austria: 1-2 days
Europe: 2-3 days

Express shipping

Austria and Germany:
Guaranteed delivery until 12:00 next day. Saturday delivery possible

Luci posteriori
taillights



NEU

Pagina /page 6

Luce di posizione laterale
side-marker lamps



Pagina /page 28

ABS, EBS, 15-poli, N/S
ABS, EBS, 15-pole, N/S



Pagina /page 44

NATO
nato



Pagina /page 54

Cablaggi vari
various cable sets



Pagina /page 64

Cablaggi speciale
special design

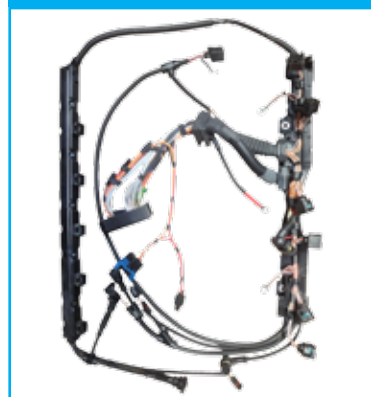

Pagina /page 69

Protezione cavi
cable protection



Pagina /page 72

Officina allestimento
factory equipment



Pagina /page 80

Informazione tecniche
technical information



Pagina /page 84

Lista di produttori di veicoli vehicle manufacturer register

adatto per veicolo fits for vehicle	Prolunga luce posteriori extension taillight	Prolunga luce di posizione laterale extension side marker lamp	Prolunga luce targa extension plate light
DAF	p. 8, 9, 10, 11	p. 36, 37	p. 10, 11
DAF dal 2013	p. 18, 19	p. 36, 37	p. 19
DAF XF	p. 24	S. 36, 37	
per div. Proplast		p. 36, 37	
per div. ULO		p. 43	
per div. Vignal		p. 34, 35	
Ford Transit	p. 25		
IVECO Daily	p. 12, 13, 14, 15	p. 38, 39	p. 14, 15, 67
IVECO Stralis	p. 22, 23, 24	p. 40, 41	p. 22, 23
IVECO Stralis Euro 6	p. 20, 21, 22, 23	p. 40, 41	p. 22, 23
IVECO Trakker Euro 6	p. 20, 21, 22, 23		p. 22, 23
IVECO Eurocargo Euro 6	p. 20, 21, 22, 23	p. 42	p. 22, 23
MAN TG	p. 8, 9, 10, 11	p. 30, 31	p. 10, 11
MAN 2000	p. 20, 21, 22, 23	p. 30, 31	p. 22, 23
Mercedes Benz	p. 12, 13, 14, 15	p. 32, 33	p. 14, 15
MB Actros dal 2012	p. 16, 17	p. 32, 33	p. 17
MB Antos dal 2012	p. 16, 17	p. 32, 33	p. 17
MB Atego	p. 20, 21, 22, 23	p. 32, 33	p. 22, 23
MB Atego dal 2013	p. 16, 17	p. 32, 33	p. 17
MB Sprinter	p. 12, 13, 14, 15	p. 43	p. 14, 15
Mitsubishi	p. 12, 13, 14, 15		p. 14, 15
Nissan Alteo Cabstar	p. 12, 13, 14, 15		p. 14, 15
Renault	p. 8, 9, 10, 11	p. 36, 37	p. 10, 11
Scania	p. 8, 9, 10, 11	p. 32, 33	p. 10, 11
Volvo	p. 8, 9, 10, 11	p. 32, 33	p. 10, 11
VW Crafter	p. 12, 13, 14, 15		p. 14, 15



adatto per veicolo	Datore de serbatolo, sensori, etc.	Cavo di adattore per luce posteriore	Altri
fits for vehicle	tank encoder, sensors, etc.	adapercable for taillight	others
DAF			
DAF dal 2013			
DAF XF			
per div. Proplast			
per div. ULO			
per div. Vignal			
Ford Transit		p. 27	
IVECO Daily	p. 66	p. 27	
IVECO Stralis			
IVECO Stralis Euro 6			
IVECO Trakker Euro 6			
IVECO Eurocargo Euro 6			
MAN TG	p. 66	p. 26	p. 25
MAN 2000			
Mercedes Benz		p. 26	
MB Actros dal 2012			
MB Antos dal 2012			
MB Atego			
MB Atego dal 2013			
MB Sprinter	p. 66		
Mitsubishi			
Nissan Alteo Cabstar			
Renault			
Scania			
Volvo			
VW Crafter			

Luci posteriori Prolunghe

Questo gruppo di prodotti include prolunghe, cavi di raccordi e prolunghe a Y.
Sviluppiamo e produciamo varianti personalizzati.

TAILLIGHTS - EXTENSIONS

This product line includes extensions, connecting cables and Y-extensions.
We generate and manufacture custom-specific variations.

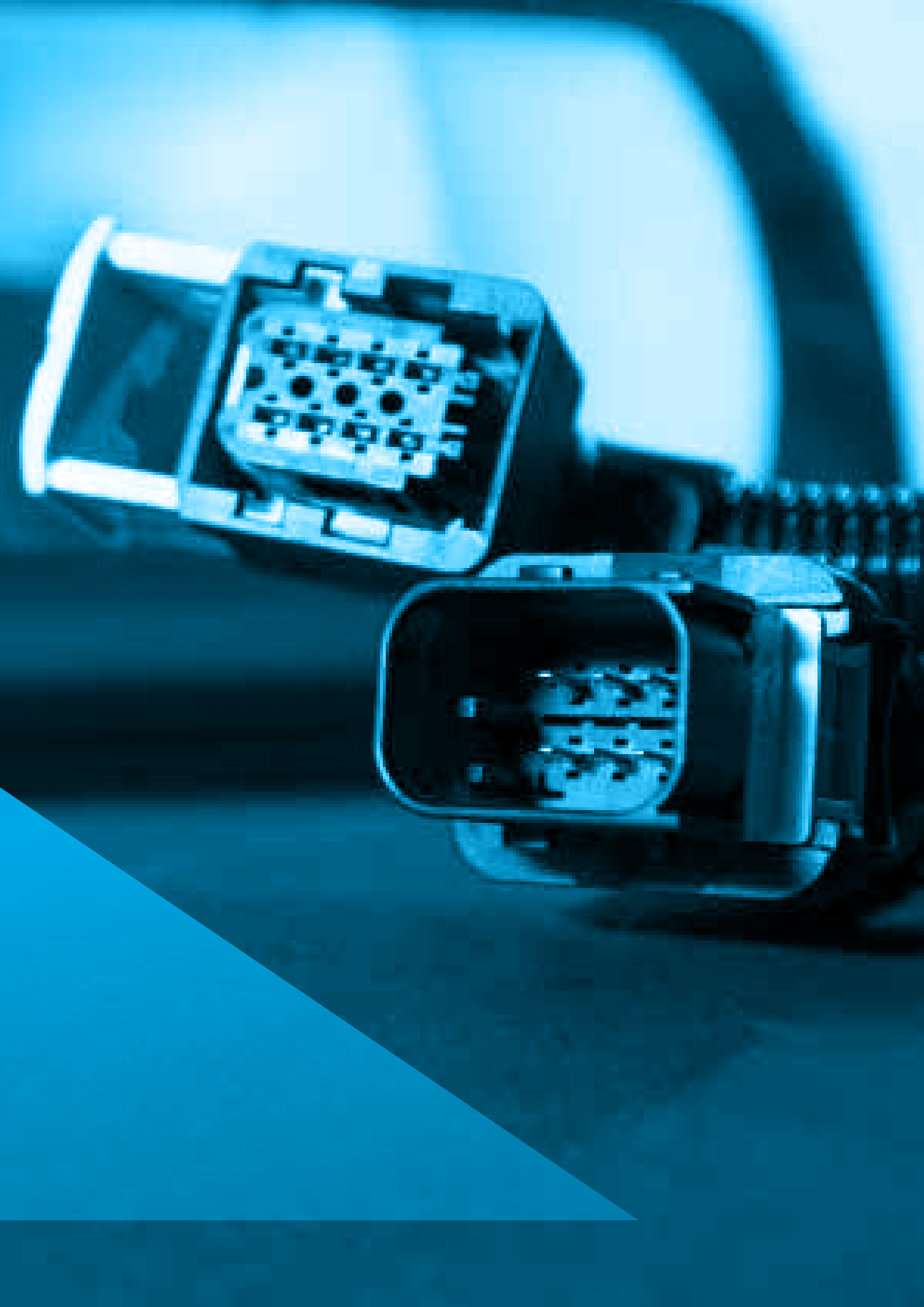



LUCI POSTERIORI

Taillights

adatto per (fits for) MAN, Scania, DAF, Renault, Volvo

Prolunga a 7 poli 90° - 7-pole extension 90°



Prolunga a 7 poli 24 V adatto per luci posteriori destra e sinistra. Adattatore 90° / 180°.
Altre lunghezze su richiesta.

7-pole extension 24 V fits for the left and the right taillight. Adapter 90° / 180°.
Further lengths on request.

adatto per fits for	no. art. Art. no.	no. di riferimento comparison no.	lunghezza length	prezzo price	
	083 100 100		1000 mm		
MANTG	083 100 160	81.25428-6982	81254286982	1600 mm	su richiesta on request
	083 100 200	82.28611-0002	82286110002	2000 mm	
	083 100 250	81.25458-6500	81254586500	2500 mm	
Scania	083 700 100		1000 mm		
	083 700 160		1600 mm	su richiesta on request	
	083 700 200		2000 mm		
	083 700 250		2500 mm		
DAF	083 800 100		1000 mm		
	083 800 160		1600 mm	su richiesta on request	
	083 800 200		2000 mm		
083 800 250		2500 mm			
Renault	083 900 100		1000 mm		
	083 900 160		1600 mm	su richiesta on request	
	083 900 200		2000 mm		
	083 900 250		2500 mm		
Volvo	183 400 100		1000 mm		
	183 400 160		1600 mm	su richiesta on request	
	183 400 200		2000 mm		
	183 400 250		2500 mm		

Prolunga a 7 poli 180° - 7-pole extension 180°



Prolunga a 7 poli 24 V adatto per luci posteriori destra e sinistra. Adattatore 2 x 180°.
Altre lunghezze su richiesta.

7-pole extension 24 V fits for the left and the right taillight. Adapter 2 x 180°.
 Further lengths on request.

adatto per fits for	no. art. Art. no.	no. di riferimento comparison no.	lunghezza length	prezzo price	
MAN TG	083 188 100	81.25428-6975	81254286975	1000 mm	su richiesta on request
	083 188 160			1600 mm	
	083 188 200			2000 mm	
	083 188 250			2500 mm	
Scania	083 788 100			1000 mm	su richiesta on request
	083 788 160			1600 mm	
	083 788 200			2000 mm	
	083 788 250			2500 mm	
DAF	083 888 100			1000 mm	su richiesta on request
	083 888 160			1600 mm	
	083 888 200			2000 mm	
Renault	083 888 250			2500 mm	su richiesta on request
	083 988 100			1000 mm	
	083 988 160			1600 mm	
	083 988 200			2000 mm	
Volvo	083 988 250			2500 mm	su richiesta on request
	183 488 100			1000 mm	
	183 488 160			1600 mm	
	183 488 200			2000 mm	
	183 488 250			2500 mm	



LUCI POSTERIORI

Taillights

adatto per (fits for) MAN, Scania, DAF, Renault, Volvo

Prolunga a 7 poli 90° + luce targa - 7-pole extension 90° + plate light



Prolunga a 7 poli 24 V con derivazione per una luce d'imbombro (58).

Opzionale:

- Per una derivazione 3° luce stop (54): (cod.-art. + "B") Es.: 083 332 162 B
- Per una derivazione luce targa: (cod.-art. + "K") Es.: 083 322 162 K

Adattatore 90° / 180°. Altre lunghezze su richiesta.

7-pole extension 24 V with a leaving for a side light (58).

Optional:

- For a leaving 3. stop light (54): (art.-no. + "B") e. g. 083 332 162 B
- For a leaving plate light: (art.-no. + "K") e. g. 083 322 162 K

Adattatore 90° / 180°. Further lengths on request.

adatto per fits for	no. art. Art. no.	no. di riferimento comparison no.	lunghezza length	esecuzione execution	prezzo price
MAN TG	083 132 162		1600 mm	2 x 1,0 mm² linea ronda	su richiesta
	083 132 202		2000 mm	2 x 1,0 mm² round cable	
	083 135 162		1600 mm	2 x 1,5 mm² Aspöck P&R	on request
	083 135 202		2000 mm	2 x 1,5 mm² Aspöck P&R	
Scania	083 732 162		1600 mm	2 x 1,0 mm² linea ronda	su richiesta
	083 732 202		2000 mm	2 x 1,0 mm² round cable	
	083 735 162		1600 mm	2 x 1,5 mm² Aspöck P&R	on request
	083 735 202		2000 mm	2 x 1,5 mm² Aspöck P&R	
DAF	083 832 162		1600 mm	2 x 1,0 mm² linea ronda	su richiesta
	083 832 202		2000 mm	2 x 1,0 mm² round cable	
	083 835 162		1600 mm	2 x 1,5 mm² Aspöck P&R	on request
	083 835 202		2000 mm	2 x 1,5 mm² Aspöck P&R	
Renault	083 932 162		1600 mm	2 x 1,0 mm² linea ronda	su richiesta
	083 932 202		2000 mm	2 x 1,0 mm² round cable	
	083 935 162		1600 mm	2 x 1,5 mm² Aspöck P&R	on request
	083 935 202		2000 mm	2 x 1,5 mm² Aspöck P&R	
Volvo	183 432 032		300 mm		su richiesta on request
	183 432 162		1600 mm	2 x 1,0 mm² linea ronda	
	183 432 202		2000 mm	2 x 1,0 mm² round cable	
	183 435 032		300 mm		
	183 435 162		1600 mm	2 x 1,5 mm² Aspöck P&R	
	183 435 202		2000 mm	2 x 1,5 mm² Aspöck P&R	

Prolunga a 7 poli 180° + luce targa - 7-pole extension 180° + plate light



Prolunga a 7 poli 24 V con derivazione per una luce d'imbombro (58).

Opzionale:

- Per una derivazione 3° luce stop (54): (cod.-art. + "B") Es.: 083 332 162 B
- Per una derivazione luce targa: (cod.-art. + "K") Es.: 083 322 162 K









Adattatore 2 x 180°. Altre lunghezze su richiesta.

7-pole extension 24 V with a leaving for a side light (58).

Optional:

- For a leaving 3. stop light (54): (art.-no. + "B") e. g. 083 332 162 B
- For a leaving plate light: (art.-no. + "K") e. g. 083 322 162 K

Adattatore 90° / 180°. Further lengths on request.

adatto per fits for	no. art. Art. no.	no. di riferimento comparison no.	lunghezza length	esecuzione execution		prezzo price
MAN TG	083 142 162		1600 mm		2 x 1,0 mm ² linea ronda	su richiesta on request
	083 142 202		2000 mm		2 x 1,0 mm ² round cable	
	083 145 162		1600 mm		2 x 1,5 mm ² Aspöck P&R	
	083 145 202		2000 mm		2 x 1,5 mm ² Aspöck P&R	
Scania	083 742 162		1600 mm		2 x 1,0 mm ² linea ronda	su richiesta on request
	083 742 202		2000 mm		2 x 1,0 mm ² round cable	
	083 745 162		1600 mm		2 x 1,5 mm ² Aspöck P&R	
	083 745 202		2000 mm		2 x 1,5 mm ² Aspöck P&R	
DAF	083 842 162		1600 mm		2 x 1,0 mm ² linea ronda	su richiesta on request
	083 842 202		2000 mm		2 x 1,0 mm ² round cable	
	083 845 162		1600 mm		2 x 1,5 mm ² Aspöck P&R	
	083 845 202		2000 mm		2 x 1,5 mm ² Aspöck P&R	
Renault	083 942 162		1600 mm		2 x 1,0 mm ² linea ronda	su richiesta on request
	083 942 202		2000 mm		2 x 1,0 mm ² round cable	
	083 945 162		1600 mm		2 x 1,5 mm ² Aspöck P&R	
	083 945 202		2000 mm		2 x 1,5 mm ² Aspöck P&R	
Volvo	183 442 032		300 mm		2 x 1,0 mm ² linea ronda 2 x 1,0 mm ² round cable	su richiesta on request
	183 442 162		1600 mm			
	183 442 202		2000 mm			
	183 445 032		300 mm			
	183 445 162		1600 mm			
183 445 202		2000 mm				



LUCI POSTERIORI

Taillights

adatto per (fits for) IVECO, Mercedes Benz, VW, Nissan, Mitsubishi

Prolunga a 7 poli 90° - 7-pole extension 90°



**Prolunga a 7 poli 24 V adatto per luci posteriori destra e sinistra. Adattatore 90° / 180°.
Altre lunghezze su richiesta.**

7-pole extension 24 V fits for the left and right taillight. Adapter 90° / 180°.
Further lengths on request.

adatto per fits for	no. art. Art. no.	no. di riferimento comparison no.	lunghezza length	prezzo price
IVECO Daily	083 300 100		1000 mm	su richiesta on request
	083 300 160		1600 mm	
	083 300 200		2000 mm	
	083 300 250		2500 mm	
Mercedes Benz	083 500 100		1000 mm	su richiesta on request
	083 500 160		1600 mm	
	083 500 200		2000 mm	
	083 500 250		2500 mm	
VW Crafter	183 100 100		1000 mm	su richiesta on request
	183 100 160		1600 mm	
	183 100 200		2000 mm	
	183 100 250		2500 mm	
Nissan Alteo Cabstar	183 300 100		1000 mm	su richiesta on request
	183 300 160		1600 mm	
	183 300 200		2000 mm	
	183 300 250		2500 mm	
Mitsubishi	183 200 100		1000 mm	su richiesta on request
	183 200 160		1600 mm	
	183 200 200		2000 mm	
	183 200 250		2500 mm	

Prolunga a 7 poli 180° - 7-pole extension 180°

Prolunga a 7 poli 24 V adatto per luci posteriori destra e sinistra. Adattatore 2 x 180°.
Altre lunghezze su richiesta.

7-pole extension 24 V fits for the left and right taillight. Adapter 2 x 180°.
 Further lengths on request.

adatto per fits for	no. art. Art. no.	no. di riferimento comparison no.	lunghezza length	prezzo price
IVECO Daily	083 388 100		1000 mm	su richiesta on request
	083 388 160		1600 mm	
	083 388 200		2000 mm	
	083 388 250		2500 mm	
Mercedes Benz	083 588 100		1000 mm	su richiesta on request
	083 588 160		1600 mm	
	083 588 200		2000 mm	
	083 588 250		2500 mm	
VW Crafter	183 188 100		1000 mm	su richiesta on request
	183 188 160		1600 mm	
	183 188 200		2000 mm	
	183 188 250		2500 mm	
Nissan Alteo Cabstar	183 388 100		1000 mm	su richiesta on request
	183 388 160		1600 mm	
	183 388 200		2000 mm	
	183 388 250		2500 mm	
Mitsubishi	183 288 100		1000 mm	su richiesta on request
	183 288 160		1600 mm	
	183 288 200		2000 mm	
	183 288 250		2500 mm	



LUCI POSTERIORI

Taillights

adatto per (fits for) IVECO, Mercedes Benz, VW, Nissan, Mitsubishi

Prolunga a 7 poli 90° + luce targa - 7-pole extension 90° + plate light



Prolunga a 7 poli 24 V con derivazione per una luce d'imbombro (58).

Opzionale:

- Per una derivazione 3° luce stop (54): (cod.-art. + "B") Es.: 083 332 162 B
- Per una derivazione luce targa: (cod.-art. + "K") Es.: 083 322 162 K

Adattatore 90° / 180°. Altre lunghezze su richiesta.

7-pole extension 24 V with a leaving for a side light (58).

Optional:

- For a leaving 3. stop light (54): (art.-no. + "B") e. g. 083 332 162 B
- For a leaving plate light: (art.-no. + "K") e. g. 083 322 162 K

Adattatore 90° / 180°. Further lengths on request.

adatto per fits for	no. art. Art. no.	no. di riferimento comparison no.	lunghezza length	esecuzione execution	prezzo price
IVECO Daily	083 332 162		1600 mm	2 x 1,0 mm² linea ronda	su richiesta on request
	083 332 202		2000 mm	2 x 1,0 mm² round cable	
	083 335 162		1600 mm	2 x 1,5 mm² Aspöck P&R	
	083 335 202		2000 mm	2 x 1,5 mm² Aspöck P&R	
	083 337 162		1600 mm	2 x 0,75 mm² Aspöck DC	
	083 337 202		2000 mm	2 x 0,75 mm² Aspöck DC	
Mercedes Benz	083 532 162		1600 mm	2 x 1,0 mm² linea ronda	su richiesta on request
	083 532 202		2000 mm	2 x 1,0 mm² round cable	
	083 535 162		1600 mm	2 x 1,5 mm² Aspöck P&R	
	083 535 202		2000 mm	2 x 1,5 mm² Aspöck P&R	
VW Crafter	183 132 162		1600 mm	2 x 1,0 mm² linea ronda	su richiesta on request
	183 132 202		2000 mm	2 x 1,0 mm² round cable	
	183 135 162		1600 mm	2 x 1,5 mm² Aspöck P&R	
	183 135 202		2000 mm	2 x 1,5 mm² Aspöck P&R	
Nissan Alteo Cabstar	183 332 162		1600 mm	2 x 1,0 mm² linea ronda	su richiesta on request
	183 332 202		2000 mm	2 x 1,0 mm² round cable	
	183 335 162		1600 mm	2 x 1,5 mm² Aspöck P&R	
Mitsubishi	183 335 202		2000 mm	2 x 1,5 mm² Aspöck P&R	su richiesta on request
	183 232 162		1600 mm	2 x 1,0 mm² linea ronda	
	183 232 202		2000 mm	2 x 1,0 mm² round cable	
	183 235 162		1600 mm	2 x 1,5 mm² Aspöck P&R	
			2000 mm	2 x 1,5 mm² Aspöck P&R	

Prolunga a 7 poli 180° + luce targa - 7-pole extension 180° + plate light



Prolunga a 7 poli 24 V con derivazione per una luce d'imbombro (58).

Opzionale:

- Per una derivazione 3° luce stop (54): (cod.-art. + "B") Es.: 083 332 162 B
- Per una derivazione luce targa: (cod.-art. + "K") Es.: 083 322 162 K

Adattatore 2 x 180°. Altre lunghezze su richiesta.

7-pole extension 24 V with a leaving for a side light (58).

Optional:

- For a leaving 3. stop light (54): (art.-no. + "B") e. g. 083 332 162 B
- For a leaving plate light: (art.-no. + "K") e. g. 083 322 162 K

Adattatore 2 x 180°. Further lengths on request.

adatto per fits for	no. art. Art. no.	no. di riferimento comparison no.	lunghezza length	esecuzione execution	prezzo price
IVECO Daily	083 342 162		1600 mm	2 x 1,0 mm² linea ronda	su richiesta on request
	083 342 202		2000 mm	2 x 1,0 mm² round cable	
	083 345 162		1600 mm	2 x 1,5 mm² Aspöck P&R	
	083 345 202		2000 mm	2 x 1,5 mm² Aspöck P&R	
	083 347 162		1600 mm	2 x 0,75 mm² Aspöck DC	
	083 347 202		2000 mm	2 x 0,75 mm² Aspöck DC	
Mercedes Benz	083 542 162		1600 mm	2 x 1,0 mm² linea ronda	su richiesta on request
	083 542 202		2000 mm	2 x 1,0 mm² round cable	
VW Crafter	083 545 162		1600 mm	2 x 1,5 mm² Aspöck P&R	su richiesta on request
	083 545 202		2000 mm	2 x 1,5 mm² Aspöck P&R	
	183 142 162		1600 mm	2 x 1,0 mm² linea ronda	
	183 142 202		2000 mm	2 x 1,0 mm² round cable	
Nissan Alteo Cabstar	183 145 162		1600 mm	2 x 1,5 mm² Aspöck P&R	su richiesta on request
	183 145 202		2000 mm	2 x 1,5 mm² Aspöck P&R	
	183 342 162		1600 mm	2 x 1,0 mm² linea ronda	
	183 342 202		2000 mm	2 x 1,0 mm² round cable	
Mitsubishi	183 345 162		1600 mm	2 x 1,5 mm² Aspöck P&R	su richiesta on request
	183 345 202		2000 mm	2 x 1,5 mm² Aspöck P&R	
	183 242 162		1600 mm	2 x 1,0 mm² linea ronda	
	183 242 202		2000 mm	2 x 1,0 mm² round cable	
	183 245 162		1600 mm	2 x 1,5 mm² Aspöck P&R	su richiesta on request
	183 245 202		2000 mm	2 x 1,5 mm² Aspöck P&R	



LUCI POSTERIORI

Taillights

adatto per (fits for) Mercedes Benz 2012

Prolunga a 7 poli 90° - 7-pole extension 90°



Prolunga a 7 poli 24 V adatto per luci posteriori destra e sinistra. Adattatore 90° / 180°.
Altre lunghezze su richiesta.

7-pole extension 24 V fits for the left and right taillight. Adapter 90° / 180°.
Further lengths on request.

adatto per fits for	no. art. Art. no.	no. di riferimento comparison no.	lunghezza length	prezzo price
MB Actros, MB Antos dal 2012	083 005 100		1000 mm	su richiesta on request
	083 005 160		1600 mm	
	083 005 200		2000 mm	
	083 005 250		2500 mm	
MB Atego dal 2013	083 006 100		1000 mm	su richiesta on request
	083 006 160		1600 mm	
	083 006 200		2000 mm	
	083 006 250		2500 mm	

Prolunga a 7 poli 180° - 7-pole extension 180°



Prolunga a 7 poli 24 V adatto per luci posteriori destra e sinistra. Adattatore 2 x 180°.
Altre lunghezze su richiesta.

7-pole extension 24 V for the left and right taillight. Adapter 2 x 180°.
Further lengths on request.

adatto per fits for	no. art. Art. no.	no. di riferimento comparison no.	lunghezza length	prezzo price
MB Actros, MB Antos dal 2012	083 885 100		1000 mm	su richiesta on request
	083 885 160		1600 mm	
	083 885 200	A 960 440 32 53 A9604403253	2000 mm	
	083 885 250		2500 mm	
MB Atego dal 2013	083 886 100		1000 mm	su richiesta on request
	083 886 160		1600 mm	
	038 886 200		2000 mm	
	083 886 250		2500 mm	

Prolunga a 7 poli 90° + luce targa - 7-pole extension 90° + plate light

Prolunga a 7 poli 24 V con derivazione per una luce d'inbombro (58).

Opzionale:

- Per una derivazione 3° luce stop (54): (cod.-art. + "B") Es.: 083 332 162 B
- Per una derivazione luce targa: (cod.-art. + "K") Es.: 083 322 162 K

Adattatore 90° / 180°. Altre lunghezze su richiesta.

7-pole extension 24 V with a leaving for a side light (58).

Optional:

- For a leaving 3. stop light (54): (art.-no. + "B") e. g. 083 332 162 B
- For a leaving plate light: (art.-no. + "K") e. g. 083 322 162 K

Adattatore 90° / 180°. Further lengths on request.



Su richiesta possibile con 2 uscite.

On request also available with 2 leavings.

adatto per fits for	no. art. Art. no.	no. di riferimento comparison no.	lunghezza length	esecuzione execution	prezzo price
MB Actros, MB Antos dal 2012	083 325 162		1600 mm	2 x 1,0 mm ² linea ronda	su richiesta
	083 325 202		2000 mm	2 x 1,0 mm ² round cable	
	083 322 162		1600 mm	2 x 1,5 mm ² Aspöck P&R	on request
	083 322 202		2000 mm	2 x 1,5 mm ² Aspöck P&R	
MB Atego dal 2013	083 326 162		1600 mm	2 x 1,0 mm ² linea ronda	su richiesta
	083 326 202		2000 mm	2 x 1,0 mm ² round cable	
	083 356 162		1600 mm	2 x 1,5 mm ² Aspöck P&R	on request
	083 356 202		2000 mm	2 x 1,5 mm ² Aspöck P&R	

Prolunga a 7 poli 180° + luce targa - 7-pole extension 180° + plate light

Prolunga a 7 poli 24 V con derivazione per una luce d'inbombro (58).

Opzionale:

- Per una derivazione 3° luce stop (54): (cod.-art. + "B") Es.: 083 332 162 B
- Per una derivazione luce targa: (cod.-art. + "K") Es.: 083 322 162 K

Adattatore 2 x 180°. Altre lunghezze su richiesta.

7-pole extension 24 V with a leaving for a side light (58).

Optional:

- For a leaving 3. stop light (54): (art.-no. + "B") e. g. 083 332 162 B
- For a leaving plate light: (art.-no. + "K") e. g. 083 322 162 K

Adattatore 2 x 180°. Further lengths on request.



Su richiesta possibile con 2 uscite.

On request also available with 2 leavings.

adatto per fits for	no. art. Art. no.	no. di riferimento comparison no.	lunghezza length	esecuzione execution	prezzo price
MB Actros dal 2012	083 425 162		1600 mm	2 x 1,0 mm ² linea ronda	su richiesta
	083 425 202		2000 mm	2 x 1,0 mm ² round cable	
	083 422 162		1600 mm	2 x 1,5 mm ² Aspöck P&R	on request
	083 422 202		2000 mm	2 x 1,5 mm ² Aspöck P&R	
MB Atego dal 2013	083 435 162		1600 mm	2 x 1,0 mm ² linea ronda	su richiesta
	083 435 202		2000 mm	2 x 1,0 mm ² round cable	
	083 432 162		1600 mm	2 x 1,5 mm ² Aspöck P&R	on request
	083 432 202		2000 mm	2 x 1,5 mm ² Aspöck P&R	



LUCI POSTERIORI

Taillights

adatto per (fits for) DAF 2013

Prolunga a 8 poli 90° - 8-pole extension 90°



**Prolunga a 8 poli 24 V adatto per luci posteriori destra e sinistra. Adattatore 90° / 180°.
Altri lunghezze su richiesta.**

8-pole extension 24 V fits for the left and right taillight. Adapter 90° / 180°.
Further lengths on request.

adatto per fits for	no. art. Art. no.	no. di riferimento comparison no.	lunghezza length	prezzo price
DAF dal 2013	183 008 100		1000 mm	su richiesta on request
	183 008 160		1600 mm	
	183 008 200		2000 mm	
	183 008 250		2500 mm	

Prolunga a 8 poli 180° - 8-pole extension 180°



**Prolunga a 8 poli 24 V adatto per luci posteriori. Adattatore 2 x 180°.
Altri lunghezze su richiesta.**

8-pole extension 24 V fits for the left and right taillight. Adapter 2 x 180°.
Further lengths on request.

adatto per fits for	no. art. Art. no.	no. di riferimento comparison no.	lunghezza length	prezzo price
DAF dal BJ 2013	183 088 100		1000 mm	su richiesta on request
	183 088 160		1600 mm	
	183 088 200		2000 mm	
	183 088 250		2500 mm	

Prolunga a 8 poli 90° + luce targa - 8-pole extension 90° + plate light



Prolunga a 7 poli 24 V con derivazione per una luce d'imbombro (58).

Opzionale:

- Per una derivazione 3° luce stop (54): (cod.-art. + "B") Es.: 083 332 162 B
- Per una derivazione luce targa: (cod.-art. + "K") Es.: 083 322 162 K



Adattatore 90° / 180°. Altre lunghezze su richiesta.

7-pole extension 24 V with a leaving for a side light (58).

Optional:

- For a leaving 3. stop light (54): (art.-no. + "B") e. g. 083 332 162 B
- For a leaving plate light: (art.-no. + "K") e. g. 083 322 162 K

Adattatore 90° / 180°. Further lengths on request.

adatto per fits for	no. art. Art. no.	no. di riferimento comparison no.	lunghezza length	esecuzione execution	prezzo price
DAF dal 2013	183 328 162		1600 mm	 2 x 1,0 mm ² linea ronda 2 x 1,0 mm ² round cable	su richiesta on request
	183 328 202		2000 mm		
	183 358 162		1600 mm	 2 x 1,5 mm ² Aspöck P&R 2 x 1,5 mm ² Aspöck P&R	
	183 358 202		2000 mm		

Prolunga 8 poli 180° + luce targa - 8-pole extension 180° + plate light



Prolunga a 7 poli 24 V con derivazione per una luce d'imbombro (58).

Opzionale:

- Per una derivazione 3° luce stop (54): (cod.-art. + "B") Es.: 083 332 162 B
- Per una derivazione luce targa: (cod.-art. + "K") Es.: 083 322 162 K



Adattatore 2 x 180°. Altre lunghezze su richiesta.

7-pole extension 24 V with a leaving for a side light (58).

Optional:

- For a leaving 3. stop light (54): (art.-no. + "B") e. g. 083 332 162 B
- For a leaving plate light: (art.-no. + "K") e. g. 083 322 162 K

Adattatore 2 x 180°. Further lengths on request.

adatto per fits for	no. art. Art. no.	no. di riferimento comparison no.	lunghezza length	esecuzione execution	prezzo price
DAF dal 2013	183 428 162		1600 mm	 2 x 1,0 mm ² linea ronda 2 x 1,0 mm ² round cable	su richiesta on request
	183 428 202		2000 mm		
	183 458 162		1600 mm	 2 x 1,5 mm ² Aspöck P&R 2 x 1,5 mm ² Aspöck P&R	
	183 458 202		2000 mm		



LUCI POSTERIORI

Taillights

adatto per (fits for) MAN, Mercedes Benz, IVECO

Prolunga a 8 poli 90° - 8-pole extension 90°



Prolunga a 8 poli 24 V adatto per luci posteriori destra e sinistra. Adattatore 90° / 180°.
Altre lunghezze su richiesta.

8-pole extension 24 V fits for the left and right taillight. Adapter 90° / 180°.
Further lengths on request.

adatto per fits for	no. art. Art. no.	no. di riferimento comparison no.	lunghezza length	prezzo price
MAN 2000	083 200 100	81.25418-6937	81254186937	1000 mm
	083 200 160	81.25418-6938	81254186938	1600 mm
	083 200 200			2000 mm
	083 200 250			2500 mm
MB Atego	083 600 100			1000 mm
	083 600 160			1600 mm
	083 600 200			2000 mm
	083 600 250			2500 mm
dal 2013 IVECO Stralis Euro 6 IVECO Trakker Euro 6 IVECO Eurocargo Euro 6	083 004 100			1000 mm
	083 004 160			1600 mm
	083 004 200			2000 mm
	083 004 250			2500 mm

Prolunga a 8 poli 180° - 8-pole extension 180°



Prolunga a 8 poli 24 V adatto per luci posteriori destra e sinistra. Adattatore 2 x 180°.
Altre lunghezze su richiesta.

8-pole extension 24 V fits for the left and right taillight. Adapter 2 x 180°.
 Further lengths on request.

adatto per fits for	no. art. Art. no.	no. di riferimento comparison no.	lunghezza length	prezzo price
MAN 2000	083 288 100		1000 mm	su richiesta on request
	083 288 160		1600 mm	
	083 288 200		2000 mm	
	083 288 250		2500 mm	
MB Atego	083 688 100		1000 mm	su richiesta on request
	083 688 160		1600 mm	
	083 688 200		2000 mm	
	083 688 250		2500 mm	
dal 2013 IVECO Stralis Euro 6 IVECO Trakker Euro 6 IVECO Eurocargo Euro 6	083 884 100		1000 mm	su richiesta on request
	083 884 160		1600 mm	
	083 884 200		2000 mm	
	083 884 250		2500 mm	



LUCI POSTERIORI

Taillights

adatto per (fits for) MAN, Mercedes Benz, IVECO

Prolunga a 8 poli 90° + luce targa - 8-pole extension 90° + plate light



Prolunga a 8 poli 24 V con derivazione per una luce d'imbombro (58).

Opzionale:

- Per una derivazione 3° luce stop (54): (cod.-art. + "B") Es.: 083 332 162 B
- Per una derivazione luce targa: (cod.-art. + "K") Es.: 083 322 162 K

Adattatore 90° / 180°. Altre lunghezze su richiesta.

8-pole extension 24 V with a leaving for a side light (58).

Optional:

- For a leaving 3. stop light (54): (art.-no. + "B") e. g. 083 332 162 B
- For a leaving plate light: (art.-no. + "K") e. g. 083 322 162 K

Adattatore 90° / 180°. Further lengths on request.

adatto per fits for	no. art. Art. no.	no. di riferimento comparison no.	lunghezza length	esecuzione execution	prezzo price
MAN 2000	083 232 162		1600 mm	2 x 1,0 mm ² linea ronda 2 x 1,0 mm ² round cable	su richiesta
	083 232 202		2000 mm		
	083 235 162		1600 mm	2 x 1,5 mm ² Aspöck P&R 2 x 1,5 mm ² Aspöck P&R	on request
	083 235 202		2000 mm		
MB Atego	083 632 162		1600 mm	2 x 1,0 mm ² linea ronda 2 x 1,0 mm ² round cable	su richiesta
	083 632 202		2000 mm		
	083 635 162		1600 mm	2 x 1,5 mm ² Aspöck P&R 2 x 1,5 mm ² Aspöck P&R	on request
	083 635 202		2000 mm		
dal 2013 IVECO Stralis Euro 6 IVECO Trakker Euro 6 IVECO Eurocargo Euro 6	083 324 162		1600 mm	2 x 1,0 mm ² linea ronda 2 x 1,0 mm ² round cable	su richiesta
	083 324 202		2000 mm		
	083 354 162		1600 mm	2 x 1,5 mm ² Aspöck P&R 2 x 1,5 mm ² Aspöck P&R	on request
	083 354 202		2000 mm		

Prolunga a 8 poli 180° + luce targa - 8-pole extension 180° + plate light

Prolunga a 8 poli 24 V con derivazione per una luce d'imbombro (58).

Opzionale:

- Per una derivazione 3° luce stop (54): (cod.-art. + "B") Es.: 083 332 162 B
- Per una derivazione luce targa: (cod.-art. + "K") Es.: 083 322 162 K







Adattatore 2 x 180°. Altre lunghezze su richiesta.

8-pole extension 24 V with a leaving for a side light (58).

Optional:

- For a leaving 3. stop light (54): (art.-no. + "B") e. g. 083 332 162 B
- For a leaving plate light: (art.-no. + "K") e. g. 083 322 162 K

Adattatore 2 x 180°. Further lengths on request.

adatto per fits for	no. art. Art. no.	no. di riferimento comparison no.	lunghezza length	esecuzione execution	prezzo price
MAN 2000	083 242 162		1600 mm	 2 x 1,0 mm ² linea ronda 2 x 1,0 mm ² round cable	su richiesta on request
	083 242 202		2000 mm		
	083 245 162		1600 mm	 2 x 1,5 mm ² Aspöck P&R 2 x 1,5 mm ² Aspöck P&R	
	083 245 202		2000 mm		
MB Atego	083 642 162		1600 mm	 2 x 1,0 mm ² linea ronda 2 x 1,0 mm ² round cable	su richiesta on request
	083 642 202		2000 mm		
	083 645 162		1600 mm	 2 x 1,5 mm ² Aspöck P&R 2 x 1,5 mm ² Aspöck P&R	
	083 645 202		2000 mm		
dal 2013 IVECO Stralis Euro 6 IVECO Trakker Euro 6 IVECO Eurocargo Euro 6	083 424 162		1600 mm	 2 x 1,0 mm ² linea ronda 2 x 1,0 mm ² round cable	su richiesta on request
	083 424 202		2000 mm		
	083 454 162		1600 mm	 2 x 1,5 mm ² Aspöck P&R 2 x 1,5 mm ² Aspöck P&R	
	083 454 202		2000 mm		



LUCI POSTERIORI

Taillights

adatto per (fits for) DAF, IVECO, MAN, Ford

Prolunga a 8 poli 90° - 8-pole extension 90°



Prolunga a 8 poli 24 V adatto per luci posteriori destra e sinistra. Adattatore 90° / 180°.
Altre lunghezze su richiesta.

8-pole extension 24 V fits for the left and right taillight. Adapter 90° / 180°.
Further lengths on request.

adatto per fits for	no. art. Art. no.	no. di riferimento comparison no.	lunghezza length	prezzo price
DAF XF	183 800 100		1000 mm	su richiesta on request
	183 800 160		1600 mm	
	183 800 200		2000 mm	
	183 800 250		2500 mm	

Prolunga a 8 poli 180° - 8-pole extension 180°



Prolunga a 8 poli 24 V adatto per luci posteriori destra e sinistra. Adattatore 2 x 180°.
Altre lunghezze su richiesta.

8-pole extension 24 V fits for the left and the right taillight. Adapter 2 x 180°.
Further lengths on request.

adatto per fits for	no. art. Art. no.	no. di riferimento comparison no.	lunghezza length	prezzo price
DAF XF	183 888 100		1000 mm	su richiesta on request
	183 888 160		1600 mm	
	183 888 200		2000 mm	
	183 888 250		2500 mm	

Prolunga a 10 poli (8 poli) 90° - 10-pole (8-pole) extension 90°



Prolunga a 10 poli (8 poli) 24 V adatto per luci posteriori destra e sinistra. Incluso adattatore a 8-poli porta femmina con terminali e gommini. Adattatore 90° / 180°.
Altre lunghezze su richiesta.

10-pole (8-pole) extension 24 V fits for the left and right taillight.
Including 8-pole socket housing, contactors and seals. Further lengths on request.

adatto per fits for	no. art. Art. no.	no. di riferimento comparison no.	lunghezza length	prezzo price
IVECO Stralis, Trakker	083 400 100		1000 mm	su richiesta on request
	083 400 160		1600 mm	
	083 400 200		2000 mm	
	083 400 250		2500 mm	

Prolunga a Y a 7 poli 180° - Y-extension 180°

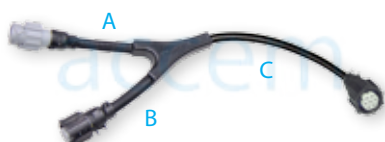

Prolunga a Y a 7 poli 24 V per il collegamento di una 2° luce posteriore.
Altre lunghezze su richiesta.

7-pole Y-extension 24 V for connection of a 2. taillight.
Further lengths on request.

adatto per fits for	no. art. Art. no.	no. di riferimento comparison no.	A in mm A in mm	B in mm B in mm	C in mm C in mm	prezzo price
MAN TG	483 025 110	81.25432-6164	81254326164	250	250	1100
	483 025 160	81.25432-6165	81254326165	250	250	1600
	483 025 200			250	250	2000
	483 025 300			250	250	3000

su richiesta
on request

Prolunga a 8 poli 180° - 8-pole extension 180°



Prolunga a 8 poli 24 V adatto per luci posteriori destra e sinistra.
Altre lunghezze su richiesta.

8-pole extension 24 V fits for the left and the right taillight.
Further lengths on request.

adatto per fits for	no. art. Art. no.	no. di riferimento comparison no.	lunghezza length	prezzo price
Ford	183 788 100		1000 mm	su richiesta on request
	183 788 160		1600 mm	
	183 788 200		2000 mm	

Prolunga a 8 poli 180° + luce targa - 8-pole extension 180° + plate light



Prolunga a 8 poli 24 V con derivazione per una luce d'imbombro (58).
Opzionale:

- Per una derivazione 3° luce stop (54): (cod.-art. + "B") Es.: 083 332 162 B
- Per una derivazione luce targa: (cod.-art. + "K") Es.: 083 322 162 K

Adattatore 2 x 180°. Altre lunghezze su richiesta.

8-pole extension 24 V with a leaving for a side light (58).
Optional:

- For a leaving 3. stop light (54): (art.-no. + "B") e. g. 083 332 162 B
- For a leaving plate light: (art.-no. + "K") e. g. 083 322 162 K

Adattatore 2 x 180°. Further lengths on request.

adatto per fits for	no. art. Art. no.	no. di riferimento comparison no.	lunghezza length	esecuzione execution	prezzo price
Ford Transit	183 742 162		1600 mm		2 x 1,0 mm² linea ronda
	183 742 202		2000 mm		2 x 1,0 mm² round cable
	183 745 162		1600 mm		2 x 1,5 mm² Aspöck P&R
	183 745 202		2000 mm		2 x 1,5 mm² Aspöck P&R
	183 747 162		1600 mm		2 x 1,5 mm² Aspöck DC
	183 747 202		2000 mm		2 x 1,5 mm² Aspöck DC

su
richiesta
on
request



LUCI POSTERIORI

Taillights

Cavo adattatore Adaptercables

Cavo adattatore a 7 poli 180° - 7-pole adapter cable 180°



Cavo adattatore a 7 poli per luci posteriore Altre lunghezze su richiesta.

7-pole adapter cable for the taillight. Further lengths on request.

adatto per fits for	no. art. Art. no.	adattatore adapter	Lunghezza length	prezzo price
da MAN TG a MB nuovo	083 043 100	90° / 180°	1000 mm	su richiesta on request
	083 043 160	90° / 180°	1600 mm	
	083 043 200	90° / 180°	2000 mm	
	083 043 250	90° / 180°	2500 mm	
da MAN TG a MB nuovo	083 843 100	2 x 180°	1000 mm	su richiesta on request
	083 843 160	2 x 180°	1600 mm	
	083 843 200	2 x 180°	2000 mm	
	083 843 250	2 x 180°	2500 mm	
	083 843 250	2 x 180°	2500 mm	

Cavo adattatore a 7 poli 90° - 7-pole adapter cable 90°



Cavo adattatore a 7 poli (con 2 connettori porta femmina) per luci posteriori. Altre lunghezze su richiesta.

7-pole adapter cable (with 2 socket housings) for the taillight. Further lengths on request.

adatto per fits for	no. art. Art. no.	adattatore adapter	lunghezza length	prezzo price
da MAN TG a MB nuovo	083 041 100	90° / 180°	1000 mm	su richiesta on request
	083 041 160	90° / 180°	1600 mm	
	083 041 200	90° / 180°	2000 mm	
	083 041 250	90° / 180°	2500 mm	
	083 041 001	90° / 180°	10000 mm	
da MAN TG a MB nuovo	083 841 100	2 x 180°	1000 mm	su richiesta on request
	083 841 160	2 x 180°	1600 mm	
	083 841 200	2 x 180°	2000 mm	
	083 841 250	2 x 180°	2500 mm	
	083 841 001	2 x 180°	10000 mm	

Cavo adattatore a 8 poli - 8-pole adapter cable

Cavo adattatore a 8 poli (con 2 connettori porta femmina) per luci posteriori. Collegamento per la luce 90°. Altre lunghezze su richiesta.

8-pole adapter cable (with 2 socket housings) for the taillight. Connection for the light 90°. Further lengths on request.

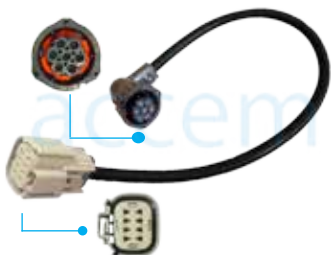

adatto per fits for	no. art. Art. no.	no. di riferimento comparison no.	lunghezza length	prezzo price
	183 047 100		1000 mm	
da Ford Transit a IVECO Daily sinistra	183 047 160		1600 mm	su richiesta on request
	183 047 200		2000 mm	
da Ford Transit a IVECO Daily destra	183 047 100		1000 mm	su richiesta on request
	183 047 160		1600 mm	su richiesta on request
	183 047 200		2000 mm	

Cavo di collegamento a 7 poli - 7-pole connecting cable

Cavo di collegamento a 7 poli (con 2 connettori porta femmina) per luci posteriori. Altre lunghezze su richiesta.

7-pole connecting cable (with 2 socket housings) for the taillight. Further lengths on request.





no. art. Art. no.	adattatore adapter	lunghezza length	prezzo price
083 140 100	90° / 180°	1000 mm	
083 140 160	90° / 180°	1600 mm	su richiesta on request
083 140 200	90° / 180°	2000 mm	
083 140 250	90° / 180°	2500 mm	
083 148 100	2 x 180°	1000 mm	
083 148 160	2 x 180°	1600 mm	su richiesta on request
083 148 200	2 x 180°	2000 mm	
083 148 250	2 x 180°	2500 mm	

Scatola di derivazione cavi - cable connection box

Scatola di derivazione cavi con 4 connettori a 7 poli a baionetta e 4 cavo di collegamento.

Cable connection box with 4 x 7-pole Bajonett-plug socket and 4 connection cables.



no. art. Art. no.	lunghezza length	esecuzione execution	prezzo price
020 472 422	2000 mm	 4 pezzi 4 piece	2 x 1,0 mm ² linea ronda 2 x 1,0 mm ² round cable
020 472 424	4000 mm		
020 475 422	2000 mm	 4 pezzi 4 piece	2 x 1,5 mm ² Aspöck P&R 2 x 1,5 mm ² Aspöck P&R
020 475 424	4000 mm		
020 474 422	2000 mm	 4 pezzi 4 piece	2 x 1,0 mm ² linea ronda ADR 2 x 1,0 mm ² round cable ADR
020 474 424	4000 mm		

Luce di posizione laterale

Prolunghe

Questo gruppo di prodotti include prolunghe, cavi di raccordi e prolunghe a Y.
Sviluppiamo e produciamo varianti personalizzati.

SIDE-MARKER LAMPS - EXTENSIONS

This product line includes extensions, connecting cables and Y-extensions.
We generate and manufacture custom-specific variations.

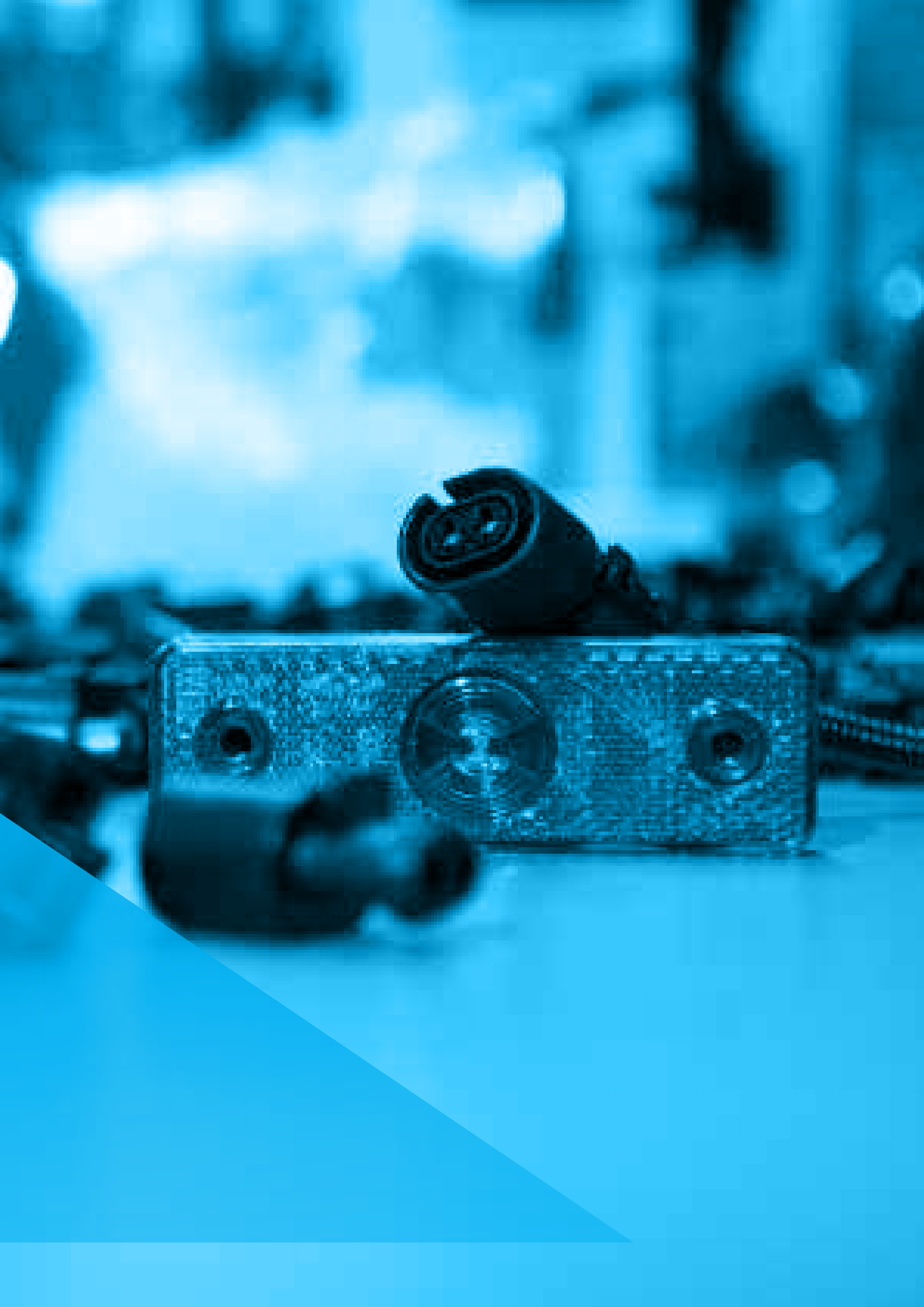



LUCE DI POSIZIONE LATERALE

Side-marker lamps



adatto per (fits for) MAN

Prolunga a 2 poli - 2-pole extension



Prolunga a 2 poli per la luce di posizione laterali.
Altre lunghezze su richiesta.

2-pole extension for the side-marker lamp.
Further lengths on request.

adatto per fits for	no. art. Art. no.	no. di riferimento comparison no.	lunghezza length	esecuzione execution	prezzo price
MAN	084 144 002		2000 mm		su richiesta on request
	084 144 004		4000 mm		
	084 142 002		2000 mm		
	084 142 004		4000 mm		

Distributore a T - T-distributor



Distributore a T a 2 vie (con 3 connettori porta maschio)

2-pole T-distributor (with 3 pin housings).



adatto per fits for	no. art. Art. no.	no. di riferimento comparison no.	prezzo price
MAN	114 020 333		su richiesta on request

Cavo di collegamento a 2 poli - 2-pole connecting cable



Cavo di collegamento a 2 poli (con 2 connettori porta femmina) per luci di posizione laterali.
Altre lunghezze su richiesta.

2-pole connecting cable (with 2 socket housings) for the side-marker lamp.
Further lengths on request.

adatto per fits for	no. art. Art. no.	no. di riferimento comparison no.	lunghezza length	esecuzione execution	prezzo price
MAN	084 164 105		150 mm		su richiesta on request
	084 164 002		2000 mm		
	084 164 004	81.25427-6757	4000 mm		
	084 162 002	81254276757	2000 mm		
	084 162 004		4000 mm		

Cavo di collegamento a 2 poli - 2-pole connecting cable



Cavo di collegamento a 2 poli per luci di posizione laterali con connettore porta maschio. Altre lunghezze su richiesta.

2-pole connecting cable for the side-marker lamp with a pin housing.
Further lengths on request.

adatto per fits for	no. art. Art. no.	no. di riferimento comparison no.	lunghezza length	esecuzione execution	prezzo price
MAN	084 122 002		2000 mm		su richiesta
	084 122 004		4000 mm		
	084 125 002		2000 mm		on request
	084 125 004		4000 mm		



Cavo di collegamento a 2 poli per 2 luci di posizione laterali con connettore porta maschio. Altre lunghezze su richiesta.

2-pole connecting cable for 2 side-marker lamps with a pin housing.
Further lengths on request.

adatto per fits for	no. art. Art. no.	no. di riferimento comparison no.	lunghezza length	esecuzione execution	prezzo price
MAN	084 122 202		2000 mm		su richiesta
	084 122 204		4000 mm		
	084 125 202		2000 mm		on request
	084 125 204		4000 mm		

Cavo di collegamento a 2 poli - 2-pole connecting cable



Cavo di collegamento a 2 poli per luci di posizione laterali con connettore porta femmina. Altre lunghezze su richiesta.

2-pole connecting cable for the side-marker lamp with a socket housing.
Further lengths on request.

adatto per fits for	no. art. Art. no.	no. di riferimento comparison no.	lunghezza length	esecuzione execution	prezzo price
MAN	084 122 102		2000 mm		su richiesta
	084 122 104		4000 mm		
	084 125 102		2000 mm		on request
	084 125 104		4000 mm		



Cavo di collegamento a 2 poli per 2 luci di posizione laterali con connettore porta femmina. Altre lunghezze su richiesta.

2-pole connecting cable for 2 side-marker lamps with a socket housing.
Further lengths on request.

adatto per fits for	no. art. Art. no.	no. di riferimento comparison no.	lunghezza length	esecuzione execution	prezzo price
MAN	084 122 302		2000 mm		su richiesta
	084 122 304		4000 mm		
	084 125 302		2000 mm		on request
	084 125 304		4000 mm		



LUCE DI POSIZIONE LATERALE

Side-marker lamps

adatto per (fits for) Mercedes Benz, Scania, Volvo

Prolunga a 2 poli - 2-pole extension



Prolunga a 2 poli per luci di posizione laterali. Altre lunghezze su richiesta.

2-pole extension for the side-marker lamp. Further lengths on request.

adatto per fits for	no. art. Art. no.	no. di riferimento comparison no.	lunghezza length	esecuzione execution	prezzo price
MB Actros Scania Volvo	084 544 002		2000 mm	2 x 1,0 mm ² tubo corrugato 2 x 1,0 mm ² corrugated tube	su richiesta on request
	084 544 004		4000 mm		
	084 542 002		2000 mm	2 x 1,0 mm ² linea ronda 2 x 1,0 mm ² round cable	
	084 542 004		4000 mm		

Prolunga a Y - Y-extension



Prolunga a Y a 2 poli per 2 luci di posizione laterali. Altre lunghezze su richiesta.

2-pole Y-extension for 2 side-marker lamps. Further lengths on request.

adatto per fits for	no. art. Art. no.	no. di riferimento comparison no.	A in mm A in mm	B in mm B in mm	C in mm C in mm	prezzo price
MB Actros Scania Volvo	084 588 201		800	1800	200	su richiesta on request
	084 588 202		1800	1800	200	
	084 588 203		1800	2800	200	
	084 588 204		1800	3800	200	

Cavo di raccordo a Y - Y-connecting cable

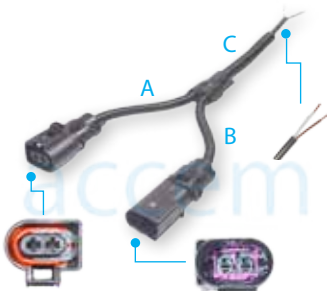

Cavo di prolunga a Y a 2 poli per la luce di posizione laterale e per il collegamento di una 2^a luce di posizione laterale. Altre lunghezze su richiesta.

2-pole Y-connecting cable for the extension of the side-marker lamp and for additional connection of a 2. side-marker lamp. Further lengths on request.

adatto per fits for	no. art. Art. no.	no. di riferimento comparison no.	A in mm	B in mm	C in mm	esecuzione execution	prezzo price
MB Actros Scania Volvo	284 502 023		250	250	3000	2 x 1,0 mm ² linea ronda 2 x 1,0 mm ² round cable	su richiesta on request
	284 505 055		500	500	5000		
	384 502 023		250	250	3000	2 x 1,5 mm ² Aspöck P&R 2 x 1,5 mm ² Aspöck P&R	
	384 505 055		500	500	5000		

Cavo di raccordo a 2 poli - 2-pole connecting cable



Cavo di raccordo a 2 poli per per luci di posizione laterali con connettore porta maschio.
Altre lunghezze su richiesta.

2-pole connecting cable for the side-marker lamp with a pin housing.
Further lengths on request.

adatto per fits for	no. art. Art. no.	no. di riferimento comparison no.	lunghezza length	esecuzione execution	prezzo price
MB Actros Scania Volvo	084 522 002		2000 mm		su richiesta
	084 522 004		4000 mm		
	084 525 002		2000 mm		on request
	084 525 004		4000 mm		



Cavo di raccordo a 2 poli per 2 luce di posizione laterale con un allaggio del connettore.
Altre lunghezze su richiesta.

2-pole connecting cable for 2 side-marker lamps with a pin housing.
Further lengths on request.

adatto per fits for	no. art. Art. no.	no. di riferimento comparison no.	lunghezza length	esecuzione execution	prezzo price
MB Actros Scania Volvo	084 522 202		2000 mm		su richiesta
	084 522 204		4000 mm		
	084 525 202		2000 mm		on request
	084 525 204		4000 mm		

Cavo di raccordo a 2 poli - 2-pole connecting cable



Cavo di raccordo a 2 poli per una luce di posizione laterale con connettore porta femmina.
Altre lunghezze su richiesta.

2-pole connecting cable for the side-marker lamp with a socket housing.
Further lengths on request.

adatto per fits for	no. art. Art. no.	no. di riferimento comparison no.	lunghezza length	esecuzione execution	prezzo price
MB Actros Scania Volvo	084 522 102		2000 mm		su richiesta
	084 522 104		4000 mm		
	084 525 102		2000 mm		on request
	084 525 104		4000 mm		



Cavo di raccordo a 2 poli per 2 luce di posizione laterale con connettore porta femmina.
Altre lunghezze su richiesta.

2-pole connecting cable for 2 side-marker lamps with a socket housing.
Further lengths on request.

adatto per fits for	no. art. Art. no.	no. di riferimento comparison no.	lunghezza length	esecuzione execution	prezzo price
MB Actros Scania Volvo	084 522 302		2000 mm		su richiesta
	084 522 304		4000 mm		
	084 525 302		2000 mm		on request
	084 525 304		4000 mm		



LUCE DI POSIZIONE LATERALE

Side-marker lamps

adatto per (fits for) div. Vignal

Prolunga a 2 poli - 2-pole extension



Prolunga a 2 poli per la luce di posizione laterale. Altre lunghezze su richiesta.

2-pole extension for the side-marker lamp. Further lengths on request.

adatto per fits for	no. art. Art. no.	no. di riferimento comparison no.	lunghezza length	esecuzione execution	prezzo price
div. Vignal	084 044 012	5010513874	2000 mm	2 x 1,0 mm ² tubo corrugato 2 x 1,0 mm ² corrugated tube	su richiesta on request
	084 044 014		4000 mm		
	084 042 012		2000 mm	2 x 1,0 mm ² linea ronda 2 x 1,0 mm ² round cable	
	084 042 014		4000 mm		

Prolunga a Y - Y-extension



Prolunga a Y a 2 poli per 2 luci di posizione laterali. Altre lunghezze su richiesta.

2-pole Y-extension for 2 side-marker lamps. Further lengths on request.

adatto per fits for	no. art. Art. no.	no. di riferimento comparison no.	A in mm A in mm	B in mm B in mm	C in mm C in mm	prezzo price
div. Vignal	084 088 201		800	1800	200	su richiesta on request
	084 088 202		1800	1800	200	
	084 088 203		1800	2800	200	
	084 088 204		1800	3800	200	

Cavo di raccordo a Y - Y-connecting cable



Cavo di prolunga a Y a 2 poli per la luce di posizione laterale e per il collegamento di una 2° luce di posizione laterale. Altre lunghezze su richiesta.

2-pole Y-connecting cable for the extension of the side-marker lamp and for additional connection of a 2. side-marker lamp. Further lengths on request.

adatto per fits for	no. art. Art. no.	no. di riferimento comparison no.	A in mm	B in mm	C in mm	esecuzione execution	prezzo price
div. Vignal	284 002 023		250	250	3000	2 x 1,0 mm ² linea ronda 2 x 1,0 mm ² round cable	su richiesta on request
	284 005 055		500	500	5000		
	384 002 023		250	250	3000	2 x 1,5 mm ² Aspöck P&R 2 x 1,5 mm ² Aspöck P&R	
	384 005 055		500	500	5000		

Cavo di raccordo a 2 poli - 2-pole connecting cable



Cavo di raccordo a 2 poli per per luci di posizione laterali con connettore porta maschio.
Altre lunghezze su richiesta.

2-pole connecting cable for the side-marker lamp with a pin housing.
Further lengths on request.

adatto per fits for	no. art. Art. no.	no. di riferimento comparison no.	lunghezza length	esecuzione execution	prezzo price
div. Vignal	084 022 012		2000 mm		su richiesta
	084 022 014		4000 mm		
	084 025 012		2000 mm		on request
	084 025 014		4000 mm		



Cavo di raccordo a 2 poli per 2 luce di posizione laterale con connettore porta maschio.
Altre lunghezze su richiesta.

2-pole connecting cable for 2 side-marker lamps with a pin housing.
Further lengths on request.

adatto per fits for	no. art. Art. no.	no. di riferimento comparison no.	lunghezza length	esecuzione execution	prezzo price
div. Vignal	084 022 212		2000 mm		su richiesta
	084 022 214		4000 mm		
	084 025 212		2000 mm		on request
	084 025 214		4000 mm		

Cavo di raccordo a 2 poli - 2-pole connecting cable



Cavo di raccordo a 2 poli per una luce di posizione laterale con connettore porta femmina.
Altre lunghezze su richiesta.

2-pole connecting cable for the side-marker lamp with a socket housing.
Further lengths on request.

adatto per fits for	no. art. Art. no.	no. di riferimento comparison no.	lunghezza length	esecuzione execution	prezzo price
div. Vignal	084 022 112		2000 mm		su richiesta
	084 022 114		4000 mm		
	084 025 112		2000 mm		on request
	084 025 114		4000 mm		



Cavo di raccordo a 2 poli con 2 luce di posizione laterale con connettore porta femmina.
Altre lunghezze su richiesta.

2-pole connecting cable for 2 side-marker lamps with a socket housing.
Further lengths on request.

adatto per fits for	no. art. Art. no.	no. di riferimento comparison no.	lunghezza length	esecuzione execution	prezzo price
div. Vignal	084 022 312		2000 mm		su richiesta
	084 022 314		4000 mm		
	084 025 312		2000 mm		on request
	084 025 314		4000 mm		



LUCE DI POSIZIONE LATERALE

Side-marker lamps

Superseal a 2 poli 2-pole Superseal

Prolunga a 2 poli - 2-pole extension



Prolunga a 2 poli per la luce di posizione laterale. Altre lunghezze su richiesta.

2-pole extension for the side-marker lamp. Further lengths on request.

adatto per fits for	no. art. Art. no.	no. di riferimento comparison no.	lunghezza length	esecuzione execution	prezzo price
div. Proplast	084 844 032		2000 mm	2 x 1,0 mm ² tubo corrugato 2 x 1,0 mm ² corrugated tube	su richiesta
	084 844 034		4000 mm		
	084 842 032		2000 mm	2 x 1,0 mm ² linea ronda 2 x 1,0 mm ² round cable	on request
	084 842 034		4000 mm		

Prolunga a Y - Y-extension

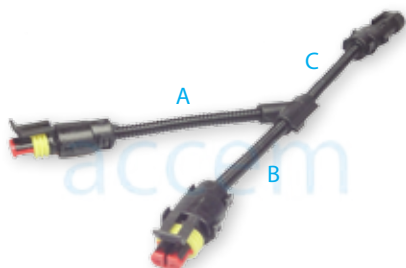

Prolunga a Y a 2 poli per 2 luci di posizione laterali. Altre lunghezze su richiesta.

2-pole Y-extension for 2 side-marker lamps. Further lengths on request.

adatto per fits for	no. art. Art. no.	no. di riferimento comparison no.	A in mm A in mm	B in mm B in mm	C in mm C in mm	prezzo price
div. Proplast	084 888 201		800	1800	200	su richiesta
	084 888 202		1800	1800	200	
	084 888 203		1800	2800	200	on request
	084 888 204		1800	3800	200	

Cavo di raccordo a Y - Y-connecting cable



Cavo di prolunga a Y a 2 poli per la luce di posizione laterale e per il collegamento di una 2° luce di posizione laterale. Altre lunghezze su richiesta.

2-pole Y-connecting cable for the extension of the side-marker lamp and for additional connection of a 2. side-marker lamp. Further lengths on request.

adatto per fits for	no. art. Art. no.	no. di riferimento comparison no.	A in mm	B in mm	C in mm	esecuzione execution	prezzo price
div. Proplast	284 802 023		250	250	3000	2 x 1,0 mm ² linea ronda 2 x 1,0 mm ² round cable	su richiesta
	284 805 055		500	500	5000		
	384 802 023		250	250	3000	2 x 1,5 mm ² Aspöck P&R 2 x 1,5 mm ² Aspöck P&R	on request
	384 805 055		500	500	5000		

Cavo di collegamento a 2 poli - 2-pole connecting cable



Cavo di abbinamento a 2 poli (con 2 scatole bussole) per la luce di posizione laterale. Altre lunghezze su richiesta.

2-pole connecting cable (with 2 socket housings) for the side-marker lamp. Further lengths on request.

adatto per fits for	no. art. Art. no.	no. di riferimento comparison no.	lunghezza length	esecuzione execution	prezzo price	
div. Proplast	084 044 032		2000 mm		2 x 1,0 mm ² tubo corrugato 2 x 1,0 mm ² corrugated tube	su richiesta
	084 044 034		4000 mm			
	084 042 032		2000 mm		2 x 1,0 mm ² linea ronda 2 x 1,0 mm ² round cable	on request
	084 042 034		4000 mm			

Cavo di collegamento a 2 poli - 2-pole connecting cable

Cavo di raccordo a 2 poli per la luce di posizione laterale con un connettore porta maschio e connettore porta femmina. Altre lunghezze su richiesta.

2-pole connecting cable for side-marker lamps with a pin housing or socket housing. Further lengths on request.



adatto per fits for	no. art. Art. no.	no. di riferimento comparison no.	lunghezza length	esecuzione execution	prezzo price	
div. Proplast	084 022 132		2000 mm		2 x 1,0 mm ² linea ronda 2 x 1,0 mm ² round cable	su richiesta
	084 022 134		4000 mm			
	084 025 132		2000 mm		2 x 1,5 mm ² Aspöck P&R 2 x 1,5 mm ² Aspöck P&R	on request
	084 025 134		4000 mm			



adatto per fits for	no. art. Art. no.	no. di riferimento comparison no.	lunghezza length	esecuzione execution	prezzo price	
div. Proplast	084 022 232		2000 mm		2 x 1,0 mm ² linea ronda 2 x 1,0 mm ² round cable	su richiesta
	084 022 234		4000 mm			
	084 025 232		2000 mm		2 x 1,5 mm ² Aspöck P&R 2 x 1,5 mm ² Aspöck P&R	on request
	084 025 234		4000 mm			



adatto per fits for	no. art. Art. no.	no. di riferimento comparison no.	lunghezza length	esecuzione execution	prezzo price	
div. Proplast	084 022 032		2000 mm		2 x 1,0 mm ² linea ronda 2 x 1,0 mm ² round cable	su richiesta
	084 022 034		4000 mm			
	084 025 032		2000 mm		2 x 1,5 mm ² Aspöck P&R 2 x 1,5 mm ² Aspöck P&R	on request
	084 025 034		4000 mm			



adatto per fits for	no. art. Art. no.	no. di riferimento comparison no.	lunghezza length	esecuzione execution	prezzo price	
div. Proplast	084 022 332		2000 mm		2 x 1,0 mm ² linea ronda 2 x 1,0 mm ² round cable	su richiesta
	084 022 334		4000 mm			
	084 025 332		2000 mm		2 x 1,5 mm ² Aspöck P&R 2 x 1,5 mm ² Aspöck P&R	on request
	084 025 334		4000 mm			



LUCE DI POSIZIONE LATERALE

Side-marker lamps

Superseal a 3 poli 3-pole Superseal

Prolunga a 3 poli - 3-pole extension



Prolunga a 2 poli per la luce di posizione laterale. Altre lunghezze su richiesta.

3-pole extension for the side-marker lamp
Further lengths on request.

adatto per fits for	no. art. Art. no.	no. di riferimento comparison no.	lunghezza length	esecuzione execution	prezzo price
IVECO Daily	084 344 002		2000 mm	2 x 1,0 mm ² tubo corrugato 2 x 1,0 mm ² corrugated tube	su richiesta on request
	084 344 004		4000 mm		
	084 342 002		2000 mm	2 x 1,0 mm ² linea ronda 2 x 1,0 mm ² round cable	
	084 342 004		4000 mm		

Prolunga a Y - Y-extension



Prolunga a Y a 2 poli per 2 luci di posizione laterali. Altre lunghezze su richiesta.

3-pole Y-extension for 2 side-marker lamps.
Further lengths on request.

adatto per fits for	no. art. Art. no.	no. di riferimento comparison no.	A in mm A in mm	B in mm B in mm	C in mm C in mm	prezzo price
IVECO Daily	084 388 201		800	1800	200	su richiesta on request
	084 388 202		1800	1800	200	
	084 388 203		1800	2800	200	
	084 388 204		1800	3800	200	

Cavo di raccordo a Y - Y-connecting cable

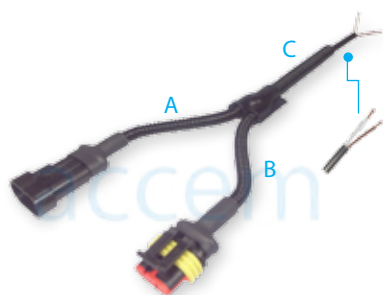

Cavo di prolunga a Y a 2 poli per la luce di posizione laterale e per il collegamento di una 2° luce di posizione laterale. Altre lunghezze su richiesta.

3-pole Y-connecting cable for the extension of the side-marker lamp and for additional connection for a 2. side-marker lamp. Further lengths on request.

adatto per fits for	no. art. Art. no.	no. di riferimento comparison no.	A in mm	B in mm	C in mm	esecuzione execution	prezzo price
IVECO Daily	284 302 023		250	250	3000	2 x 1,0 mm ² linea ronda 2 x 1,0 mm ² round cable	su richiesta on request
	284 305 055		500	500	5000		
	384 302 023		250	250	3000	2 x 1,5 mm ² Aspöck P&R 2 x 1,5 mm ² Aspöck P&R	
	384 305 055		500	500	5000		

Cavo di raccordo a 3 poli - 3-pole connecting cable



Cavo di raccordo a 3 poli per per luci di posizione laterali con connettore porta maschio. Altre lunghezze su richiesta.

3-pole connecting cable for the side-marker lamp with a pin housing.
Further lengths on request.

adatto per fits for	no. art. Art. no.	no. di riferimento comparison no.	lunghezza length	esecuzione execution	prezzo price
IVECO Daily	084 302 002		2000 mm	 2 x 1,0 mm ² linea ronda 2 x 1,0 mm ² round cable	su richiesta on request
	084 302 004		4000 mm		
	084 305 002		2000 mm	 2 x 1,5 mm ² Aspöck P&R 2 x 1,5 mm ² Aspöck P&R	
	084 305 004		4000 mm		



Cavo di raccordo a 3 poli per la destra e la sinistra luce di posizione laterale con un connettore porta maschio. Altre lunghezze su richiesta.

3-pole connecting cable for the left and the right side-marker lamp with a pin housing.
Further lengths on request.

adatto per fits for	no. art. Art. no.	no. di riferimento comparison no.	lunghezza length	esecuzione execution	prezzo price
IVECO Daily	084 302 202		2000 mm	 2 x 1,0 mm ² linea ronda 2 x 1,0 mm ² round cable	su richiesta on request
	084 302 204		4000 mm		
	084 305 202		2000 mm	 2 x 1,5 mm ² Aspöck P&R 2 x 1,5 mm ² Aspöck P&R	
	084 305 204		4000 mm		

Cavo di raccordo a 3 poli - 3-pole connecting cable



Cavo di raccordo a 3 poli per una luce di posizione laterale con connettore porta femmina. Altre lunghezze su richiesta.

3-pole connecting cable for the side-marker lamp with a socket housing.
Further lengths on request.

adatto per fits for	no. art. Art. no.	no. di riferimento comparison no.	lunghezza length	esecuzione execution	prezzo price
IVECO Daily	084 302 102		2000 mm	 2 x 1,0 mm ² linea ronda 2 x 1,0 mm ² round cable	su richiesta on request
	084 302 104		4000 mm		
	084 305 102		2000 mm	 2 x 1,5 mm ² Aspöck P&R 2 x 1,5 mm ² Aspöck P&R	
	084 305 104		4000 mm		



Cavo di raccordo a 3 poli per la destra e la sinistra luce di posizione laterale con connettore porta femmina. Altre lunghezze su richiesta.

3-pole connecting cable for the left and the right side-marker lamp with a socket housing.
Further lengths on request.

adatto per fits for	no. art. Art. no.	no. di riferimento comparison no.	lunghezza length	esecuzione execution	prezzo price
IVECO Daily	084 302 302		2000 mm	 2 x 1,0 mm ² linea ronda 2 x 1,0 mm ² round cable	su richiesta on request
	084 302 304		4000 mm		
	084 305 302		2000 mm	 2 x 1,5 mm ² Aspöck P&R 2 x 1,5 mm ² Aspöck P&R	
	084 305 304		4000 mm		



LUCE DI POSIZIONE LATERALE

Side-marker lamps

Superseal a 4 poli 4-pole Superseal

Prolunga a 4 poli - 4-pole extension



Prolunga a 2 poli per la luce di posizione laterale. Altre lunghezze su richiesta.

4-pole extension for the side-marker lamp. Further lengths on request.

adatto per fits for	no. art. Art. no.	no. di riferimento comparison no.	lunghezza length	esecuzione execution	prezzo price
IVECO Stralis	084 444 202		2000 mm		4 x 1,0 mm ² tubo corrugato
	084 444 204		4000 mm		4 x 1,0 mm ² corrugated tube
	084 442 202		2000 mm		2 x 1,0 mm ² linea ronda
	084 442 204		4000 mm		2 x 1,0 mm ² round cable

Prolunga a Y - Y-extension



Prolunga a Y a 2 poli per 2 luci di posizione laterali. Altre lunghezze su richiesta.

4-pole Y-extension for 2 side-marker lamps. Further lengths on request.

adatto per fits for	no. art. Art. no.	no. di confronto comparison no.	A in mm A in mm	B in mm B in mm	C in mm C in mm	prezzo price
IVECO Stralis	084 488 201		800	1800	200	su richiesta
	084 488 202		1800	1800	200	
	084 488 203		1800	2800	200	on request
	084 488 204		1800	3800	200	request

Cavo di raccordo a Y - Y-connecting cable

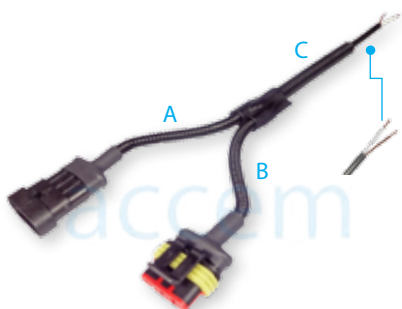

Cavo di prolunga a Y a 2 poli per la luce di posizione laterale e per il collegamento di una 2° luce di posizione laterale. Altre lunghezze su richiesta.

4-pole Y-connecting cable for the extension of the side-marker lamp and for additional connection of a 2. side-marker lamp. Further lengths on request.

adatto per fits for	no. art. Art. no.	no. di riferimento comparison no.	A in mm	B in mm	C in mm	esecuzione execution	prezzo price
IVECO Stralis	284 402 023		250	250	3000		2 x 1,0 mm ² linea ronda
	284 405 055		500	500	5000		2 x 1,0 mm ² round cable
	384 402 023		250	250	3000		2 x 1,5 mm ² linea ronda
	384 405 055		500	500	5000		2 x 1,5 mm ² Aspöck P&R

Cavo di raccordo a 4 poli - 4-pole connecting cable



Cavo di raccordo a 4 poli per per luci di posizione laterali con connettore porta maschio. Altre lunghezze su richiesta.

4-pole connecting cable for the side-marker lamp with a pin housing.
Further lengths on request.

adatto per fits for	no. art. Art. no.	no. di riferimento comparison no.	lunghezza length	esecuzione execution	prezzo price
IVECO Stralis	084 402 002		2000 mm		su richiesta
	084 402 004		4000 mm		
	084 405 002		2000 mm		on request
	084 405 004		4000 mm		

Cavo di raccordo a 4 poli per la destra e la sinistra luce di posizione laterale con un connettore porta maschio. Altre lunghezze su richiesta.

4-pole connecting cable for the left and the right side-marker lamp with a pin housing.
Further lengths on request.



adatto per fits for	no. art. Art. no.	no. di riferimento comparison no.	lunghezza length	esecuzione execution	prezzo price
IVECO Stralis	084 402 202		2000 mm		su richiesta
	084 402 204		4000 mm		
	084 405 202		2000 mm		on request
	084 405 204		4000 mm		

Cavo di raccordo a 4 poli - 4-pole connecting cable

Cavo di raccordo a 4 poli per una luce di posizione laterale con connettore porta femmina. Altre lunghezze su richiesta.

4-pole connecting cable for the side-marker lamp with a socket housing.
Further lengths on request.



adatto per fits for	no. art. Art. no.	no. di riferimento comparison no.	lunghezza length	esecuzione execution	prezzo price
IVECO Stralis	084 402 102		2000 mm		su richiesta
	084 402 104		4000 mm		
	084 405 102		2000 mm		on request
	084 405 104		4000 mm		

Cavo di raccordo a 4 poli per la destra e la sinistra luce di posizione laterale con connettore porta femmina. Altre lunghezze su richiesta.

4-pole connecting cable for the left and the right side-marker lamp with a socket housing.
Further lengths on request.



adatto per fits for	no. art. Art. no.	no. di riferimento comparison no.	lunghezza length	esecuzione execution	prezzo price
IVECO Stralis	084 402 302		2000 mm		su richiesta
	084 402 304		4000 mm		
	084 405 302		2000 mm		on request
	084 405 304		4000 mm		



LUCE DI POSIZIONE LATERALE

Side-marker lamps

Superseal a 4 poli 4-pole Superseal

Cavo di raccordo a 4 poli - 4-pole connecting cable



Cavo di raccordo a 4 poli per la destra e la sinistra luce di posizione laterale con un connettore porta maschio. Altre lunghezze su richiesta.

4-pole connecting cable for the left and the right side-marker lamp with a pin housing.
Further lengths on request.

adatto per fits for	no. art. Art. no.	no. di riferimento comparison no.	lunghezza length	esecuzione execution	prezzo price	
IVECO Eurocargo	184 402 202		2000 mm		2 x 1,0 mm ² linea ronda	su richiesta
	184 402 204		4000 mm		2 x 1,0 mm ² round cable	
	184 405 202		2000 mm		2 x 1,5 mm ² Aspöck P&R	on request
	184 405 204		4000 mm		2 x 1,5 mm ² Aspöck P&R	

Cavo di raccordo a 4 poli - 4-pole connecting cable



Cavo di raccordo a 4 poli per la destra e la sinistra luce di posizione laterale con connettore porta femmina. Altre lunghezze su richiesta.

4-pole connecting cable for the left and the right side-marker lamp with a socket housing.
Further lengths on request.

adatto per fits for	no. art. Art. no.	no. di riferimento comparison no.	lunghezza length	esecuzione execution	prezzo price	
IVECO Eurocargo	184 402 302		2000 mm		2 x 1,0 mm ² linea ronda	su richiesta
	184 402 304		4000 mm		2 x 1,0 mm ² round cable	
	184 405 302		2000 mm		2 x 1,5 mm ² Aspöck P&R	on request
	184 405 304		4000 mm		2 x 1,5 mm ² Aspöck P&R	

adatto per (fits for) MB Sprinter, div. ULO

Cavo di collegamento a 2 poli - 2-pole connecting cable



Cavo di raccordo a 2 poli per una luce di posizione laterale con connettore porta femmina. Altre lunghezze su richiesta.

2-pole connecting cable for a side-marker lamp with a socket housing.
Further lengths on request.

adatto per fits for	no. art. Art. no.	no. di riferimento comparison no.	lunghezza length	esecuzione execution	prezzo price	
div. ULO	084 022 022		2000 mm		2 x 1,0 mm ² linea ronda	su richiesta
	084 022 024		4000 mm		2 x 1,0 mm ² round cable	
	084 025 022		2000 mm		2 x 1,5 mm ² Aspöck P&R	on request
	084 025 024		4000 mm		2 x 1,5 mm ² Aspöck P&R	



Cavo di raccordo a 2 poli per 2 luce di posizione laterale con connettore porta femmina. Altre lunghezze su richiesta.

2-pole connecting cable for 2 side-marker lamps with a socket housing.
Further lengths on request.

adatto per fits for	no. art. Art. no.	no. di riferimento comparison no.	lunghezza length	esecuzione execution	prezzo price	
div. ULO	084 022 222		2000 mm		2 x 1,0 mm ² linea ronda	su richiesta
	084 022 224		4000 mm		2 x 1,0 mm ² round cable	
	084 025 222		2000 mm		2 x 1,5 mm ² Aspöck P&R	on request
	084 025 224		4000 mm		2 x 1,5 mm ² Aspöck P&R	

Cavo di raccordo a 3 poli - 3-pole connecting cable



Cavo di raccordo a 3 poli per per luci di posizione laterali con connettore porta maschio. Altre lunghezze su richiesta.

3-pole connecting cable for a side-marker lamp with a pin housing.
Further lengths on request.

adatto per fits for	no. art. Art. no.	no. di riferimento comparison no.	lunghezza length	esecuzione execution	prezzo price	
MB Sprinter	184 502 002		2000 mm		2 x 1,0 mm ² linea ronda	su richiesta
	184 502 004		4000 mm		2 x 1,0 mm ² round cable	
	184 505 002		2000 mm		2 x 1,5 mm ² Aspöck P&R	on request
	184 505 004		4000 mm		2 x 1,5 mm ² Aspöck P&R	



Cavo di raccordo a 3 poli per 2 per luci di posizione laterali con connettore porta maschio. Altre lunghezze su richiesta.

3-pole connecting cable for 2 side-marker lamps with a pin housing.
Further lengths on request.

adatto per fits for	no. art. Art. no.	no. di riferimento comparison no.	lunghezza length	esecuzione execution	prezzo price	
MB Sprinter	184 502 202		2000 mm		2 x 1,0 mm ² linea ronda	su richiesta
	184 502 204		4000 mm		2 x 1,0 mm ² round cable	
	184 505 202		2000 mm		2 x 1,5 mm ² Aspöck P&R	on request
	184 505 204		4000 mm		2 x 1,5 mm ² Aspöck P&R	

ABS, EBS, 15-poli, N/S Prolunghe

Questo gruppo di prodotti include prolunghe, cavi di raccordi e prolunghe a Y.
Sviluppiamo e produciamo varianti personalizzati.

ABS, EBS, 15-pole, N/S - EXTENSIONS

This product line includes extensions, connecting cables and Y-extensions.
We generate and manufacture custom-specific variations.





ABS, EBS, 15-poli, N/S

ABS, EBS, 15-pole, N/S

Prolunghe extensions

ABS prolunga a 5 poli 24 V - 5-pole ABS extension 24 V



ABS prolunga a 5 poli (3 x 1,5 mm² + 2 x 4 mm²) 24 V PUR con tenuta del conduttore singolo. Altre lunghezze su richiesta.

5-pole ABS extension (3 x 1,5 mm² + 2 x 4 mm²) 24 V PUR with single sealed conductors. Further lengths on request.

no. art. Art. no.	lunghezza length	prezzo price
083 310 100	1000 mm	su richiesta on request
083 310 150	1500 mm	
083 310 200	2000 mm	
083 310 250	2500 mm	
083 310 300	3000 mm	

EBS prolunga a 7 poli 24 V - 7-pole EBS extension 24 V



EBS prolunga a 7 poli (5 x 1,5 mm² + 2 x 4 mm²) 24 V PUR con tenuta del conduttore singolo. Altre lunghezze su richiesta.

7-pole EBS extension (5 x 1,5 mm² + 2 x 4 mm²) 24 V PUR with single sealed conductors. Further lengths on request.

no. art. Art. no.	lunghezza length	prezzo price
083 510 100	1000 mm	su richiesta on request
083 510 150	1500 mm	
083 510 200	2000 mm	
083 510 250	2500 mm	
083 510 300	3000 mm	

Prolunga a 15 poli 24 V - 15-pole extension 24V



Prolunga a 15 poli (12 x 1,5 mm² + 3 x 2,5 mm²) 24 V PUR con tenuta del conduttore singolo. Altre lunghezze su richiesta.

15-pole extension (12 x 1,5 mm² + 3 x 2,5 mm²) 24 V PUR with single sealed conductors. Further lengths on request.

Art. - Nr. Art. no.	Länge length	Preis price
083 515 100	1000 mm	su richiesta on request
083 515 150	1500 mm	
083 515 200	2000 mm	
083 515 250	2500 mm	
083 515 300	3000 mm	

Cavo a spirale spiral lines

ABS cavo a spirale a 5 poli 12 V - 5-pole ABS spiral cable 12 V



ABS cavo a spirale a 5 poli (3 x 1,5 mm² + 2 x 4 mm²) 12 V PUR con un diametro di elica di 35 mm.

5-pole ABS spiral cable (3 x 1,5 mm² + 2 x 4 mm²) 12 V PUR with a diameter of the spiral of 35 mm.

no. art. Art. no.	lunghezza length	prezzo price
880 513 240	4500 mm	su richiesta on request

EBS cavo a spirale a 7 poli 24 V - 7-pole EBS spiral cable 24 V



EBS cavo a spirale a 7 poli (5 x 1,5 mm² + 2 x 4 mm²) 24 V PUR con un diametro di elica di 35 mm.

7-pole EBS spiral cable (5 x 1,5 mm² + 2 x 4 mm²) 24 V PUR with a diameter of the spiral of 35 mm.

no. art. Art. no.	lunghezza length	prezzo price
880 702 345	4500 mm	su richiesta on request

Cavo a spirale a 15 poli 24 V - 15-pole spiral cable 24 V



Cavo a spirale a 15 poli (12 x 1,5 mm² + 3 x 2,5 mm²) 24 V PUR con un diametro di elica di 35 mm.

15-pole spiral cable (12 x 1,5 mm² + 3 x 2,5 mm²) 24 V PUR with a diameter of the spiral of 35 mm.

no. art. Art. no.	lunghezza length	prezzo price
881 502 345	4500 mm	su richiesta on request



ABS, EBS, 15-poli, N/S

ABS, EBS, 15-pole, N/S

Cavo di collegamento connecting cable

con 2 spine - with 2 plugs



Cavo di collegamento (con 2 spine) 24 V PUR per ABS, EBS o 15-poli.
Altre lunghezze su richiesta.

Connecting cable (with 2 plugs) 24 V PUR for ABS, EBS or 15-pole.
Further lengths on request.

esecuzione execution	no. art. Art. no.	lunghezza length	prezzo price
ABS	383 310 100	1000 mm	su richiesta on request
	383 310 150	1500 mm	
	383 310 200	2000 mm	
	383 310 250	2500 mm	
	383 310 300	3000 mm	
EBS	383 510 100	1000 mm	su richiesta on request
	383 510 150	1500 mm	
	383 510 200	2000 mm	
	383 510 250	2500 mm	
	383 510 300	3000 mm	
15-poli	383 515 100	1000 mm	su richiesta on request
	383 515 150	1500 mm	
	383 515 200	2000 mm	
	383 515 250	2500 mm	
	383 515 300	3000 mm	

con 2 prese - with 2 sockets



Cavo di collegamento (con 2 prese) 24 V PUR per ABS, EBS o 15-poli.
Altre lunghezze su richiesta.

Connecting cable (with 2 sockets) 24 V PUR for ABS, EBS or 15-pole.
Further lengths on request.

esecuzione execution	no. art. Art. no.	lunghezza length	prezzo price
ABS	583 310 100	1000 mm	su richiesta on request
	583 310 150	1500 mm	
	583 310 200	2000 mm	
	583 310 250	2500 mm	
	583 310 300	3000 mm	
EBS	583 510 100	1000 mm	su richiesta on request
	583 510 150	1500 mm	
	583 510 200	2000 mm	
	583 510 250	2500 mm	
	583 510 300	3000 mm	
15-poli	583 515 100	1000 mm	su richiesta on request
	583 515 150	1500 mm	
	583 515 200	2000 mm	
	583 515 250	2500 mm	
	583 515 300	3000 mm	

Cavo di collegamento connecting cable

con 1 spina - with 1 plug



Cavo di collegamento (con 1 spina) 24 V PUR per ABS, EBS o 15-poli.
Altre lunghezze su richiesta.

Connecting cable (with 1 plug) 24 V PUR for ABS, EBS or 15-pole.
 Further lengths on request.

esecuzione execution	no. art. Art. no.	lunghezza length	prezzo price
ABS	083 330 100	1000 mm	su richiesta on request
	083 330 150	1500 mm	
	083 330 200	2000 mm	
	083 330 250	2500 mm	
	083 330 300	3000 mm	
EBS	083 530 100	1000 mm	su richiesta on request
	083 530 150	1500 mm	
	083 530 200	2000 mm	
	083 530 250	2500 mm	
	083 530 300	3000 mm	
15-poli	083 535 100	1000 mm	su richiesta on request
	083 535 150	1500 mm	
	083 535 200	2000 mm	
	083 535 250	2500 mm	
	083 535 300	3000 mm	

con 1 presa - with 1 socket



Cavo di collegamento (con 1 presa) 24 V PUR per ABS, EBS o 15-poli.
Altre lunghezze su richiesta.

Connecting cable (with 1 socket) 24 V PUR for ABS, EBS or 15-pole.
 Further lengths on request.

esecuzione execution	no. art. Art. no.	lunghezza length	prezzo price
ABS	083 320 100	1000 mm	su richiesta on request
	083 320 150	1500 mm	
	083 320 200	2000 mm	
	083 320 250	2500 mm	
	083 320 300	3000 mm	
EBS	083 520 100	1000 mm	su richiesta on request
	083 520 150	1500 mm	
	083 520 200	2000 mm	
	083 520 250	2500 mm	
	083 520 300	3000 mm	
15-poli	083 525 100	1000 mm	su richiesta on request
	083 525 150	1500 mm	
	083 525 200	2000 mm	
	083 525 250	2500 mm	
	083 525 300	3000 mm	



ABS, EBS, 15-poli, N/S

ABS, EBS, 15-pole, N/S

Adattatore di cavo cableadapter

Y-EBS - Y-EBS

ISO 7638-1



Adattatore di cavo 24 V PUR con una EBS spina a 7 poli e 2 x EBS prese a 7 poli. Altre lunghezze su richiesta.

Cableadapter 24 V PUR with a 7-pole EBS plug and 2 x 7-pole EBS sockets. Further lengths on request.

no. art. Art. no.	lunghezza length	lunghezza length	prezzo price
283 510 051 0	500 mm	1000 mm	su richiesta on request
283 510 101 0	1000 mm	1000 mm	
283 510 202 0	2000 mm	2000 mm	
283 510 303 0	3000 mm	3000 mm	

Y-15-poli - Y-15-pole

ISO 12098



Adattatore di cavo 24 V PUR con una spina a 15 poli e 2 x prese a 15 poli. Altre lunghezze su richiesta.

Cableadapter 24 V PUR with a 15-pole plug and 2 x 15-pole sockets. Further lengths on request.

no. art. Art. no.	lunghezza length	lunghezza length	prezzo price
283 515 051 0	500 mm	1000 mm	su richiesta on request
283 515 101 0	1000 mm	1000 mm	
283 515 202 0	2000 mm	2000 mm	
283 515 303 0	3000 mm	3000 mm	

15-poli su 15-poli+ N/S - 15-pole at 15-pole + N/S

**ISO 12098,
ISO 1185 + ISO 3731**



Adattatore di cavo 24 V PUR con una spina a 15 poli, una presa a 15 poli e 2 x prese a 7 poli tipo N/S. Altre lunghezze su richiesta.

Cableadapter 24 V PUR with a 15-pole plug, a 15-pole socket and 2 x 7-pole sockets type N/S. Further lengths on request.

no. art. Art. no.	lunghezza 15-poli lengths 15-pole	lunghezza N length N	lunghezza S Length S	prezzo price
283 505 05NS	500 mm	1000 mm	1000 mm	su richiesta on request
283 510 10NS	1000 mm	1000 mm	1000 mm	
283 520 20NS	2000 mm	2000 mm	2000 mm	
283 530 30NS	3000 mm	3000 mm	3000 mm	

15-poli su N/S - 15-pole at N/S

**ISO 12098,
ISO 1185 + ISO 3731**



Adattatore di cavo 24 V PUR con una spina a 15 poli e 2 x prese a 7 poli tipo N/S. Altre lunghezze su richiesta.

Cableadapter 24 V PUR with a 15-pole plug and 2 x 7-pole sockets type N/S. Further lengths on request.

no. art. Art. no.	lunghezza N length N	lunghezza S length S	prezzo price
283 005 05NS	500 mm	500 mm	su richiesta on request
283 010 10NS	1000 mm	1000 mm	
283 020 20NS	2000 mm	2000 mm	
283 030 30NS	3000 mm	3000 mm	

Y-15-poli - br/sw - Y-15-pole - br/bl

ISO 12098



Adattatore di cavo 24 V PUR/PA6 con una presa a 15 poli e 2 x allaggio del connettore a 8 poli br/sw. Altre lunghezze su richiesta.

Cableadapter 24 V PUR/PA6 with a 15-pole socket and 2 x 8-pole pin housing br/bl. Further lengths on request.

no. art. Art. no.	no. di riferimento comparison no.	lunghezza length	prezzo price
283 205 150	81.25432-6177	1500 mm	
283 205 250		2500 mm	su richiesta on request
283 205 350		3500 mm	

15-poli- N/S adattatore - 15-pole - N/S adapter

ISO 12098,
ISO 1185 + ISO 3731



Adattatore di una 24 V presa a 15 poli su 2 x 24 V spine a 7 poli tipo N/S.

Adapter of 15-pole 24 V socket on 2 x 7-pole 24 V plugs type N/S.

no. art. Art. no.	prezzo price
651 577 191	su richiesta on request

7-poli cavo a spirale tipo S - 7-pole spiral cable type S

ISO 3731



Cavo a spirale a 7 poli (6 x 1,0 mm² + 1 x 1,5 mm²) 24 V PUR tipo S con un diametro di elica di 20 mm.

7-pole spiral cable (6 x 1,0 mm² + 1 x 1,5 mm²) 24 V PUR type S with a diameter of the spiral of 20 mm.

no. art. Art. no.	lunghezza length	prezzo price
881 702 145	4500 mm	su richiesta on request

7-poli cavo a spirale tipo N - 7-pole spiral cable type N

ISO 1185



Cavo a spirale a 7 poli (6 x 1,0 mm² + 1 x 1,5 mm²) 24 V PUR tipo N con un diametro di elica di 20 mm.

7-pole spiral cable (6 x 1,0 mm² + 1 x 1,5 mm²) 24 V PUR type N with a diameter of the spiral of 20 mm.

no. art. Art. no.	lunghezza length	prezzo price
881 702 045	4500 mm	su richiesta on request



ABS, EBS, 15-poli, N/S

ABS, EBS, 15-pole, N/S

Prolunghe extensions

Prolunga a 8 poli marrone S - 8-pole extension brown S



Prolunga a 8 poli marrone (S) connettori porta maschio e porta femmina. Altre lunghezze su richiesta.

8-pole extension brown (S) with a pin housing and a socket housing. Further lengths on request.

adatto per fits for	no. art. Art. no.	no. di riferimento comparison no.	lunghezza length	prezzo price
	083 810 050		500 mm	
MANTG	083 810 100	81.25428-6973	1000 mm	su richiesta on request
	083 810 150	81.25428-6974	1500 mm	

Prolunga a Y a 8 poli marrone S - 8-pole Y-extension brown S



Prolunga a Y marrone (S) a 8 poli, 1 x connettore porta maschio e 2 x porta femmina. Altre lunghezze su richiesta.

Y-extension brown (S) with a 8-pole pin housing and 2 x 8-pole socket housing. Further lengths on request.

adatto per fits for	no. art. Art. no.	no. di riferimento comparison no.	lunghezza length	prezzo price
	283 810 050	81.25432-6174	500 mm	
MANTG	283 810 100		1000 mm	su richiesta on request
	283 810 200		2000 mm	
	283 810 300		3000 mm	

Prolunga a 7 poli tipo 24 S - 7-pole type 24 S extension



Pres a 7 poli tipo 24 S con connettore porta maschio 8 vie marrone. Altre lunghezze su richiesta.

7-pole socket type 24 S on 8-pole pin housing brown. Further lengths on request.

adatto per fits for	no. art. Art. no.	no. di riferimento comparison no.	lunghezza length	prezzo price
	S83 810 100		1000 mm	
	S83 810 150		1500 mm	
MANTG	S83 810 200	81.25432-6202	2000 mm	su richiesta on request
	S83 810 250		2500 mm	
	S83 810 300		3000 mm	

Prolunga a 7 poli tipo 24 S - 7-pole type 24 S extension



Pres a 7 poli tipo 24 S su spina a 7 poli tipo 24 S. Altre lunghezze su richiesta.

7-pole socket type 24 S on 7-pole plug type 24 S. Further lengths on request.

no. art. Art. no.	lunghezza length	prezzo price
E 032 432 010	1000 mm	
E 032 432 015	1500 mm	
E 032 432 020	2000 mm	
E 032 432 025	2500 mm	
E 032 432 030	3000 mm	

su richiesta on request

Prolunga a 8 poli nero N - 8-pole extension black N



Prolunga a 8 poli ner (N), connettori porta maschio e porta femmina.

Altre lunghezze su richiesta.

8-pole extension black (N) with a pin housing and a socket housing.
Further lengths on request.

adatto per fits for	no. art. Art. no.	no. di riferimento comparison no.	lunghezza length	prezzo price
	083 820 050		500 mm	
MAN TG	083 820 100	81.25428-6971	81254286971	1000 mm
	083 820 150	81.25428-6972	81254286972	1500 mm

su richiesta
on request

Prolunga a Y a 8 poli nero N - 8-pole Y-extension black N



Prolunga a Y nero (N), 1 x connettore porta maschio a 8 poli e 2 x porta femmina a 8 poli.

Altre lunghezze su richiesta.

Y-extension black (N) with a 8-pole pin housing and 2 x 8-pole socket housing.
Further lengths on request.

adatto per fits for	no. art. Art. no.	no. di riferimento comparison no.	lunghezza length	prezzo price
	283 820 050	81.25432-6173	81254326173	500 mm
MAN TG	283 820 100			1000 mm
	283 820 200			2000 mm
	283 820 300			3000 mm

su richiesta
on request

Prolunga a 7 poli tipo 24 N - 7-pole type 24 N extension



Pres a 7 poli tipo 24 S con connettore porta maschio 8 vie marrone. Altre lunghezze su richiesta.

7-pole socket type 24 N on 8-pole pin housing black. Further lengths on request.

adatto per fits for	no. art. Art. no.	no. di riferimento comparison no.	lunghezza length	prezzo price
	N83 820 100			1000 mm
	N83 820 150			1500 mm
MAN TG	N83 820 200	81.25432-6201	81254326201	2000 mm
	N83 820 250			2500 mm
	N83 820 300			3000 mm

su richiesta
on request

Prolunga a 7 poli tipo 24 N - 7-pole type 24 N extension



Pres a 7 poli tipo 24 N su spina a 7 poli tipo 24 N. Altre lunghezze su richiesta.

7-pole socket type 24 N on 7-pole plug type 24 N. Further lengths on request.

no. art. Art. no.	lunghezza length	prezzo price
E 032 431 010	1000 mm	
E 032 431 015	1500 mm	
E 032 431 020	2000 mm	
E 032 431 025	2500 mm	
E 032 431 030	3000 mm	

su richiesta
on request

NATO

**Questo gruppo di prodotti include cavi di collegamento e cavi d'accensione esterni.
Sviluppiamo e produciamo varianti personalizzati.**

NATO

**This product line includes connecting cables, foreign jump lead etc.
We generate and manufacture custom-specific variations.**





NATO

NATO

NATO VG 96917

Cavo di collegamento - connecting cable

VG 96917



Nato VG 96917 cavo di collegamento a 2 poli con 2 Nato-spine con anello filettato e una frizione con cappuccio involuto. Altre lunghezze su richiesta.

2-pole Nato VG 96917 connecting cable with 2 Nato-plugs with ring nut and a coupling with screw caps. Further lengths on request.

no. art. Art. no.	sezione cross-section	lunghezza length	prezzo price
656 228 335	2 x 35 mm ²	3500 mm	
656 228 360	2 x 35 mm ²	6000 mm	
656 228 380	2 x 35 mm ²	8000 mm	
656 228 310	2 x 35 mm ²	10000 mm	su richiesta on request
656 228 315	2 x 35 mm ²	15000 mm	
656 228 320	2 x 35 mm ²	20000 mm	
656 228 325	2 x 35 mm ²	25000 mm	
<hr/>			
656 228 535	2 x 50 mm ²	3500 mm	
656 228 560	2 x 50 mm ²	6000 mm	
656 228 580	2 x 50 mm ²	8000 mm	
656 228 510	2 x 50 mm ²	10000 mm	su richiesta on request
656 228 515	2 x 50 mm ²	15000 mm	
656 228 520	2 x 50 mm ²	20000 mm	
656 228 525	2 x 50 mm ²	25000 mm	

Cavo di collegamento - connecting cable

VG 96917



Nato VG 96917 cavo di collegamento a 2 poli con 2 Nato-spine vulcanizzate con anello filettato e una frizione vulcanizzata con cappuccio involuto. Altre lunghezze su richiesta.

2-pole Nato VG 96917 connecting cable with 2 molded Nato-plugs with ring nut and a molded coupling with screw cap. Further lengths on request.

no. art. Art. no.	sezione cross-section	lunghezza length	prezzo price
656 227 335	2 x 35 mm ²	3500 mm	
656 227 360	2 x 35 mm ²	6000 mm	
656 227 380	2 x 35 mm ²	8000 mm	
656 227 310	2 x 35 mm ²	10000 mm	su richiesta on request
656 227 315	2 x 35 mm ²	15000 mm	
656 227 320	2 x 35 mm ²	20000 mm	
656 227 325	2 x 35 mm ²	25000 mm	
<hr/>			
656 227 535	2 x 50 mm ²	3500 mm	
656 227 560	2 x 50 mm ²	6000 mm	
656 227 580	2 x 50 mm ²	8000 mm	
656 227 510	2 x 50 mm ²	10000 mm	su richiesta on request
656 227 515	2 x 50 mm ²	15000 mm	
656 227 520	2 x 50 mm ²	20000 mm	
656 227 525	2 x 50 mm ²	25000 mm	

Cavo di collegamento - connecting cable
VG 96917

Nato VG 96917 cavo di collegamento a 2 poli con 2 Nato-spine e una frizione.
Altre lunghezze su richiesta.

2-pole Nato VG 96917 connecting cable with 2 Nato-plugs and a coupling.
 Further lengths on request.

no. art. Art. no.	sezione cross-section	lunghezza length	prezzo price
656 229 335	2 x 35 mm ²	3500 mm	su richiesta on request
656 229 360	2 x 35 mm ²	6000 mm	
656 229 380	2 x 35 mm ²	8000 mm	
656 229 310	2 x 35 mm ²	10000 mm	
656 229 315	2 x 35 mm ²	15000 mm	
656 229 320	2 x 35 mm ²	20000 mm	
656 229 325	2 x 35 mm ²	25000 mm	
656 229 535	2 x 50 mm ²	3500 mm	su richiesta on request
656 229 560	2 x 50 mm ²	6000 mm	
656 229 580	2 x 50 mm ²	8000 mm	
656 229 510	2 x 50 mm ²	10000 mm	
656 229 515	2 x 50 mm ²	15000 mm	
656 229 520	2 x 50 mm ²	20000 mm	
656 229 525	2 x 50 mm ²	25000 mm	

Cavo di collegamento - connecting cable
VG 96917

Nato VG 96917 cavo di collegamento con 2 Nato-spine con cappuccio involuto.
Altre lunghezze su richiesta.

2-pole Nato VG 96917 connecting cable with 2 Nato-sockets with ring nut.
 Further lengths on request.

no. art. Art. no.	sezione cross-section	lunghezza length	prezzo price
656 223 335	2 x 35 mm ²	3500 mm	su richiesta on request
656 223 360	2 x 35 mm ²	6000 mm	
656 223 380	2 x 35 mm ²	8000 mm	
656 223 310	2 x 35 mm ²	10000 mm	
656 223 315	2 x 35 mm ²	15000 mm	
656 223 320	2 x 35 mm ²	20000 mm	
656 223 325	2 x 35 mm ²	25000 mm	
656 223 535	2 x 50 mm ²	3500 mm	su richiesta on request
656 223 560	2 x 50 mm ²	6000 mm	
656 223 580	2 x 50 mm ²	8000 mm	
656 223 510	2 x 50 mm ²	10000 mm	
656 223 515	2 x 50 mm ²	15000 mm	
656 223 520	2 x 50 mm ²	20000 mm	
656 223 525	2 x 50 mm ²	25000 mm	



NATO

NATO

NATO VG 96917

Cavo a spirale - spiral cable

VG 96917



Nato VG 96917 cavo a spirale a 2 poli PUR 35 mm² con 2 Nato-spine gommata con anello filettato.

2-pole Nato VG 96917 spiral cable PUR 35 mm² with 2 gummed Nato-plug with ring nut.

no. art. Art. no.	sezione cross-section	lunghezza length	prezzo price
889 206 240	2 x 35 mm ²	4500 mm	su richiesta on request

Cavo a spirale - spiral cable

VG 96917



Nato VG 96917 cavo a spirale a 2 poli PUR 35 mm² con 2 Nato-spine con anello filettato.

2-pole Nato VG 96917 spiral cable PUR 35 mm² with 2 Nato-plugs with ring nut.

no. art. Art. no.	sezione cross-section	lunghezza length	prezzo price
888 206 240	2 x 35 mm ²	4500 mm	su richiesta on request

Nato-spina - Nato-plug

VG 96917



VG 96917 spina a 2 poli con contatti. Esecuzione con o senza anello filettato (AF).

2-pole Nato VG 96917 plug including contacts. Execution with or without ring nut (RN).

no. art. Art. no.	sezione cross-section	esecuzione execution	prezzo price
656 222 365	35 - 50 mm ²	verde - con AF	green - with RN
656 220 365	35 - 50 mm ²	verde - con AF	green - without RN
656 221 365	35 - 50 mm ²	nero - senza AF	black - without RN
656 224 365	35 - 50 mm ²	nero - plastica - senza AF	black - plastic - without RN
656 227 365	35 - 50 mm ²	nero - gommato - con AF	black - gummed - with RN

su richiesta
on request

Nato-presa - Nato-socket

VG 96917



Nato VG 96917 presa a 2 poli con contatti.

2-pole Nato VG 96917 socket including contacts.

no. art. Art. no.	sezione cross-section	esecuzione execution	prezzo price
656 220 383	35 mm ² , 50 mm ²	verde	green
656 222 383	35 mm ² , 50 mm ²	giallo	yellow
656 221 383	35 mm ² , 50 mm ²	nero	black
656 224 383	35 mm ² , 50 mm ²	nero - plastica	black - plastic

su richiesta
on request

Presca con condotto - socket with cable

VG 96917



opzionale pre montato
optional pre-assembled

Nato-presca a 2 poli con condotto finito per connettere e protezione di cavo PA6. Per una becca di gomma pre montato [no. art. + "G"]. Es.: "656 220 308 G". Altre lunghezze su richiesta.

2-pole Nato-socket with a ready for connection cable and cable protection PA6. For a pre-assembled rubber grommet [art. no. + "G"]. Example: "656 220 308 G". Further lengths on request.

no. art. Art. no.	sezione cross-section	lunghezza length	prezzo price
656 220 308	2 x 35 mm ²	800 mm	su richiesta on request
656 220 320	2 x 35 mm ²	2000 mm	
656 220 330	2 x 35 mm ²	3000 mm	
656 220 340	2 x 35 mm ²	4000 mm	
656 220 350	2 x 35 mm ²	5000 mm	
656 220 508	2 x 50 mm ²	800 mm	su richiesta on request
656 220 520	2 x 50 mm ²	2000 mm	
656 220 530	2 x 50 mm ²	3000 mm	
656 220 540	2 x 50 mm ²	4000 mm	
656 220 550	2 x 50 mm ²	5000 mm	

Angolare universale - universal mounting bracket

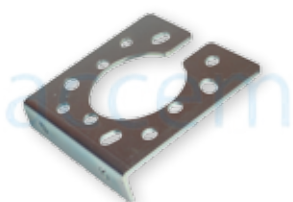

Angolare universale per ABS, EBS, 15-poli e Nato-presca.

Universal mounting bracket for ABS, EBS, 15-pole and Nato-sockets.

no. art. Art. no.	materiale material	prezzo price
037 001 002	acciaio - blu zincato steel - blue zincated	su richiesta on request
037 001 003	acciaio - inossidabile acciaio steel - stainless steel	

Becca di gomma - rubber grommet

VG 96917



Becca di gomma a 2 poli per Nato VG 96917 presa adatto per cavo (D 9,9 - 11,75 mm) e tubo corrugato (NW 13).

2-pole rubber grommet for Nato VG 96917 socket fits for cable (D 9,9 - 11,75 mm) and corrugated pipe (NW 13).

no. art. Art. no.	prezzo price
030 656 383	su richiesta on request



NATO

NATO

Cavi d'accensione jump leads

Nato cavo d'accensione - Nato jump lead

VG 96917



Nato VG 96917 cavo d'accensione a 2 poli con 2 pinze di lamiera d'acciaio completamente isolato di 600 A con inserti dei poli di gettata e nastro di rame e 1 Nato-spina. Altre lunghezze su richiesta.

2-pole Nato VG 96917 jump lead with 2 all-insulated 600 A steel plate pliers with cast pole inserts and CU-band and 1 Nato-plug. Further lengths on request.

no. art. Art. no.	sezione cross-section	lunghezza length	prezzo price
656 225 335	2 x 35 mm ²	3500 mm	
656 225 350	2 x 35 mm ²	5000 mm	su richiesta on request
656 225 360	2 x 35 mm ²	6000 mm	
656 225 535	2 x 50 mm ²	3500 mm	
656 225 550	2 x 50 mm ²	5000 mm	su richiesta on request
656 225 560	2 x 50 mm ²	6000 mm	

Cavo d'accensione aperto - jump lead open

VG 96917



Cavo d'accensione a 2 poli con 2 pinze di lamiera d'acciaio completamente isolato di 600 A con 2 inserti dei poli di gettata e nastro di rame e coda aperta. Altre lunghezze su richiesta.

2-pole jump lead with 2 all-insulated 600 A steel plate pliers with cast pole inserts and CU-band and open end. Further lengths on request.

no. art. Art. no.	sezione cross-section	lunghezza length	prezzo price
E 830 635 635	2 x 35 mm ²	3500 mm	
E 830 635 650	2 x 35 mm ²	5000 mm	su richiesta on request
E 830 635 660	2 x 35 mm ²	6000 mm	
E 830 650 635	2 x 50 mm ²	3500 mm	
E 830 650 650	2 x 50 mm ²	5000 mm	su richiesta on request
E 830 650 660	2 x 50 mm ²	6000 mm	

Cavo d'accensione - jump lead

VG 96917



Cavo d'accensione a 2 poli con 4 pinze di lamiera d'acciaio completamente isolato di 600 A con inserti dei poli di gettata e nastro di rame. Altre lunghezze su richiesta.

2-pole jump lead with 4 all-insulated 600 A steel plate pliers with cast pole inserts and CU-band. Further lengths on request.

no. art. Art. no.	sezione cross-section	lunghezza length	prezzo price
830 635 635	2 x 35 mm ²	3500 mm	
830 635 650	2 x 35 mm ²	5000 mm	su richiesta on request
830 635 660	2 x 35 mm ²	6000 mm	
830 650 635	2 x 50 mm ²	3500 mm	
830 650 650	2 x 50 mm ²	5000 mm	su richiesta on request
830 650 660	2 x 50 mm ²	6000 mm	

Cavi d'accensione a gomito jump leads cranked

Nato cavo d'accensione a gomito - Nato jump lead cranked

VG 96917



Nato VG 96917 cavo d'accensione a 2 poli con 2 pinze piena gettata completamente isolato di 900 A e nastro di rame e 1 Nato-spina. Altre lunghezze su richiesta.

2-pole Nato VG 96917 jump lead with 2 cranked all-insulating 900 A full-cast pliers and CU-band and 1 Nato-plug. Further lengths on request.

no. art. Art. no.	sezione cross-section	lunghezza length	prezzo price
656 225 335 G	2 x 35 mm ²	3500 mm	
656 225 350 G	2 x 35 mm ²	5000 mm	su richiesta on request
656 225 360 G	2 x 35 mm ²	6000 mm	
656 225 535 G	2 x 50 mm ²	3500 mm	
656 225 550 G	2 x 50 mm ²	5000 mm	su richiesta on request
656 225 560 G	2 x 50 mm ²	6000 mm	

Cavo d'accensione a gomito aperto - jump lead cranked open

VG 96917



Cavo d'accensione a 2 poli con 2 pinze piena gettata completamente isolato di 900 A e nastro di rame e una coda aperta. Altre lunghezze su richiesta.

2-pole jump lead with 2 cranked all-insulating 900 A full-cast pliers and CU-band and open end. Further lengths on request.

no. art. Art. no.	sezione cross-section	lunghezza length	prezzo price
E 830 635 635 G	2 x 35 mm ²	3500 mm	
E 830 635 650 G	2 x 35 mm ²	5000 mm	su richiesta on request
E 830 635 660 G	2 x 35 mm ²	6000 mm	
E 830 650 635 G	2 x 50 mm ²	3500 mm	
E 830 650 650 G	2 x 50 mm ²	5000 mm	su richiesta on request
E 830 650 660 G	2 x 50 mm ²	6000 mm	

Cavo d'accensione a gomito - jump lead cranked

VG 96917



Cavo d'accensione a 2 poli con 4 pinze piena gettata completamente isolato di 900 A e nastro di rame. Altre lunghezze su richiesta.

2-pole jump lead with 4 cranked all-insulating 900 A full-cast pliers and CU-band. Further lengths on request.

Art. - Nr. Art. no.	Querschnitt cross-section	Länge length	Preis price
830 635 635 G	2 x 35 mm ²	3500 mm	
830 635 650 G	2 x 35 mm ²	5000 mm	su richiesta on request
830 635 660 G	2 x 35 mm ²	6000 mm	
830 650 635 G	2 x 50 mm ²	3500 mm	
830 650 650 G	2 x 50 mm ²	5000 mm	su richiesta on request
830 650 660 G	2 x 50 mm ²	6000 mm	



NATO

NATO

Cavi d'accensione jump leads

Nato cavo d'accensione - Nato jump lead

VG 96917



Nato VG 96917 cavo d'accensione a 2 poli con 2 pinze di lamiera d'acciaio completamente isolato di 600 A con inserti dei poli di gettata e nastro di rame e 1 Nato-spina con anello filettato. Altre lunghezze su richiesta.

2-pole Nato VG 96917 jump lead with 2 all-insulated 600 A steel plate pliers with cast pole inserts and CU-band and 1 Nato-plug with ring nut. Further lengths on request.

no. art. Art. no.	sezione cross-section	lunghezza length	prezzo price
656 226 315	2 x 35 mm ²	1500 mm	
656 226 335	2 x 35 mm ²	3500 mm	su richiesta
656 226 350	2 x 35 mm ²	5000 mm	on request
656 226 360	2 x 35 mm ²	6000 mm	
656 226 513	2 x 50 mm ²	1500 mm	
656 226 535	2 x 50 mm ²	3500 mm	su richiesta
656 226 550	2 x 50 mm ²	5000 mm	on request
656 226 560	2 x 50 mm ²	6000 mm	

Cavi d'accensione a gomito jump leads cranked

Nato cavo d'accensione a gomito - Nato jump lead cranked

VG 96917



Nato VG 96917 cavo d'accensione a 2 poli con 2 pinze piena gettata completamente isolato di 900 A e nastro di rame e 1 Nato-spina con anello filettato. Altre lunghezze su richiesta.

2-pole Nato VG 96917 jump lead with 2 cranked all-insulating 900 A full-cast pliers and CU-band and 1 Nato-plug with ring nut. Further lengths on request.

no. art. Art. no.	sezione cross-section	lunghezza length	prezzo price
656 226 315 G	2 x 35 mm ²	1500 mm	
656 226 335 G	2 x 35 mm ²	3500 mm	su richiesta on request
656 226 350 G	2 x 35 mm ²	5000 mm	
656 226 360 G	2 x 35 mm ²	6000 mm	
656 226 515 G	2 x 50 mm ²	1500 mm	
656 226 535 G	2 x 50 mm ²	3500 mm	su richiesta on request
656 226 550 G	2 x 50 mm ²	5000 mm	
656 226 560 G	2 x 50 mm ²	6000 mm	

Cablaggi vari

Questo gruppo di prodotti include , estensione per MV, sensori, datore de serbatoio, illuminazione per la targe ecc. Sviluppiamo e produciamo variante costumizzato.

VARIOUS CABLE SETS

This product line includes, extensions for magnetic valve, sensors, tank encoder, plate light etc. We generate and manufacture custom-specific variations.





CABLAGGI VARI

various cable sets

Datore de serbatolo, sensori, etc. tank encoder, sensors, etc.

Prolunga a 4 poli 90° - 4-pole extension 90°



Prolunga a 4 poli per blocco di valvola, sensori, datore de serbatolo, Altre lunghezze su richiesta.
4-pole extension for valve block, sensors, tank encoder, Further lengths on request.

adatto per fits for	no. art. Art. no.	no. di riferimento comparison no.	adattatore adapter	lunghezza length	prezzo price
MAN TG	085 200 001		90° / 180°	1000 mm	su richiesta on request
	085 200 002		90° / 180°	2000 mm	
	085 200 003		90° / 180°	3000 mm	
	085 200 004		90° / 180°	4000 mm	

Prolunga a 4 poli 180° - 4-pole extension 180°



Prolunga a 4 poli per blocco di valvola, sensori, datore de serbatolo, Altre lunghezze su richiesta.
4-pole extension for valve block, sensors, tank encoder, Further lengths on request.

adatto per fits for	no. art. Art. no.	no. di riferimento comparison no.	adattatore adapter	lunghezza length	prezzo price
MAN TG	085 288 001		2 x 180°	1000 mm	su richiesta on request
	085 288 002		2 x 180°	2000 mm	
	085 288 003		2 x 180°	3000 mm	
	085 288 004		2 x 180°	4000 mm	

Prolunga a 4 poli 2 x 90° - 4-pole extension 2 x 90°



Prolunga a 4 poli per il datore de serbatolo. Altre lunghezze su richiesta.
4-pole extension for the tank encoder. Further lengths on request.

adatto per fits for	no. art. Art. no.	no. di riferimento comparison no.	adattatore adapter	lunghezza length	prezzo price
IVECO Daily	085 400 001		2 x 90°	1000 mm	su richiesta on request
	085 400 002		2 x 90°	2000 mm	
	085 400 003		2 x 90°	3000 mm	
	085 400 004		2 x 90°	4000 mm	

Prolunga a 4 poli 180° - 4-pole extension 180°



Prolunga a 4 poli per sensore sospensioni pneumatiche. Altre lunghezze su richiesta.
4-pole extension for sensor cushioning. Further lengths on request.

adatto per fits for	no. art. Art. no.	no. di riferimento comparison no.	adattatore adapter	lunghezza length	prezzo price
MB Sprinter	085 588 005		2 x 180°	500 mm	su richiesta on request
	085 588 010		2 x 180°	1000 mm	
	085 588 020		2 x 180°	2000 mm	

Prolunga a 3 poli 180° - 3-pole extension 180°



Estensione a 2- (3-) poli per la luce targa.
Inclusivo connettore porta femmina a 2 poli, contatti e seals. Altre lunghezze su richieste.
 2- (3-) pole extension for the plate light.
 Including 2-pole socket housing, contacts and seals. Further lengths on request.

adatto per fits for	no. art. Art. no.	no. di riferimento comparison no.	adattatore adapter	lunghezza length	prezzo price
IVECO Daily	086 444 060		90° / 180°	600 mm	su richiesta on request
	086 444 100		90° / 180°	1000 mm	
	086 444 160		90° / 180°	1600 mm	
	086 444 200		90° / 180°	2000 mm	
	086 444 300		90° / 180°	3000 mm	

Distributore - junction board



Distributore con 5 possibilità di connettere: per connettore di porta femmina a 8 poli e spina di 37 poli con contatti.
 Junction board with 5 possible connections: for 8-pole socket housing and 37-pole plug with contacts.

adatto per fits for	no. art. Art. no.	no. di riferimento comparison no.	prezzo price
MAN		81 25435 0523	81250350523

su richiesta
on request

Adattatore - adapter



Adattatore (breve) di 7 poli 12 V su innesto di 13 poli.
 Adapter (short) 7-pole 12 V at 13-pole coupling.

no. art. Art. no.	no. di riferimento comparison no.	prezzo price
651 731 183		su richiesta on request

Adattatore - adapter



Adattatore (breve) di 13 poli 12 V su innesto di 7 poli.
 Adapter (short) 13-pole 12 V at 7-pole coupling.

no. art. Art. no.	no. di riferimento comparison no.	prezzo price
651 371 183		su richiesta on request



CABLAGGI VARI

various cable sets

Cavo di collegamento connection

Cavo di collegamento a 16 poli - 16 pole connection



Connettore porta femmina a 16 poli DAF Bodybuilder A152 con cavo di 2m.

16 pole socket housing for DAF Bodybuilder A 152 with 2m cable.

adatto per fits for	no. art. Art. no.	no. di riferimento comparison no.	precio price
DAF Bodybuilder	183 016 201 C	AELF996	su richiesta on request

16 poli HDSCS connettore porta femmina

1	9
2	10
3	11
4	12
5	13
6	14
7	15
8	16

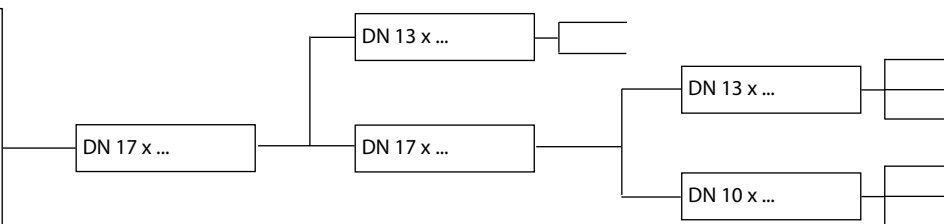

Esempio:

16 poli HDSCS connettore porta femmina

1_1,5 mm ² ge	9
2_2,5 mm ² ws	10
3	11
4	12
5	13
6	14
7	15
8	16

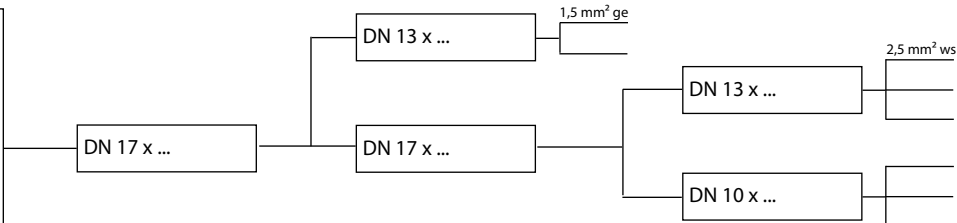

Legenda di colore:

bl: blu/blue ge: giallo/yellow gr: gregio/grey rt: rosso/red vi: viola/purple rs: rosa/pink
br: marrone/brown gn: verde/green nt: natura/nature sw: nero/black ws: bianco/white or: arancione/orange

Cablaggi - cable manufacturing

Cablaggi speciali

special model, special cable



Come fornitore di servizi nell'area set di cavi confezioniamo da più di 30 anni cavi con abbinamento di brasata, spina, crimp o bullone a misura per parecchi settore varie e scopo di utilizzo.

Come azienda intermedia siamo altamente flessibile. Alloggiamo apparecchio automatici e macchine nella confezione di cavi su aiuti del trasformazione dei cavi cioè lavorazione dei cavi, per costruzione dei pezzi unici serie minime e versione speciale.

La nostra vendita, insieme team di progetto, accompagna Lei con impegno personale dal sviluppo al processo di produzione.

Vantaggi per nostri clienti

- 1 Migliore qualità garantita da personale con esperienza anossa
- 2 Ultima flessibilità e desbrigo dei ordine rapido
- 3 Brevi tempi di consegna

As service provider in the range of cable sets we tailor cables for over 30 years with solder-, crimp- or bolted connection to measure for a lot of several sectors and application areas.

As a midsize company we are ultraflexible. We insert our automats and machines in the cable manufacturing as auxiliary material for cable processing, for construction of individual pieces, mini-series and special equipment.

Our distribution, together with our projectteam, accompany you with personally commitment from processing to production process.

Advantages for our clients

- 1 Best quality guaranteed by long-standing trouper
- 2 Top flexibility and fast order transaction
- 3 Short delivery times



DIVERSE KABELSÄTZE

various cable sets

accem - Automotive GmbH

Maderspergerstraße 10
4560 Kirchdorf/Krems
Österreich

office@accem.at
www.accem.at
TEL. +43 7582 / 61219 - 0
FAX. +43 7582 / 61219 - 30

Modello di fax per tipo speciale

Modello:

16 poli HDSCS connettore porta femmina

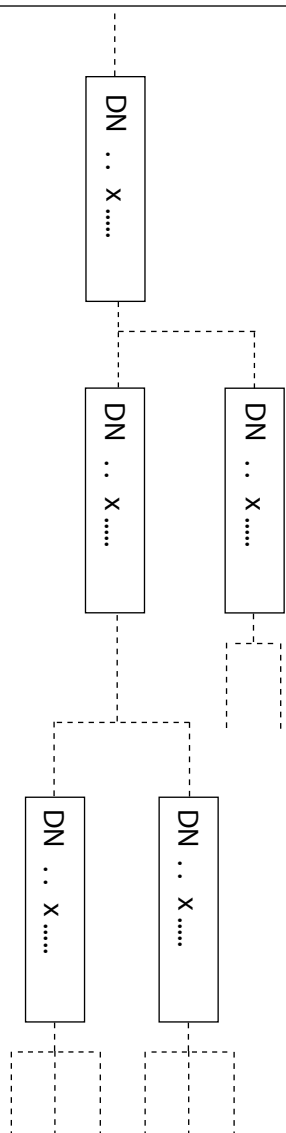
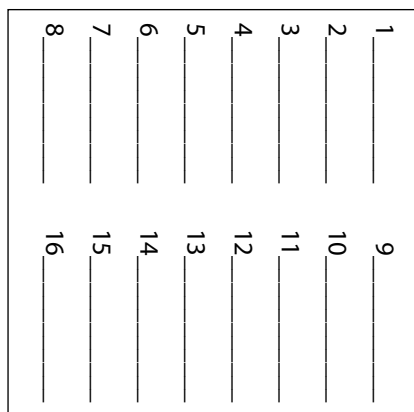

Esempio:

16 poli HDSCS connettore porta femmina

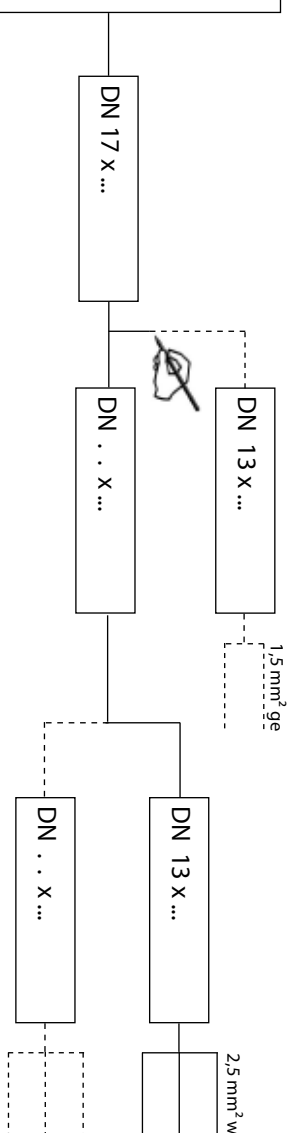
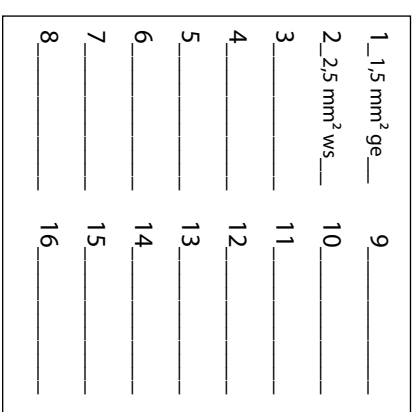



Protezione cavi

Questo gruppo di prodotti include tubo corrugato, incamiciatura isolante, tubo intrecciato e accessori.

CABLE PROTECTION

This product line includes corrugated pipe, insulating tube, braided sleeve and accessories.

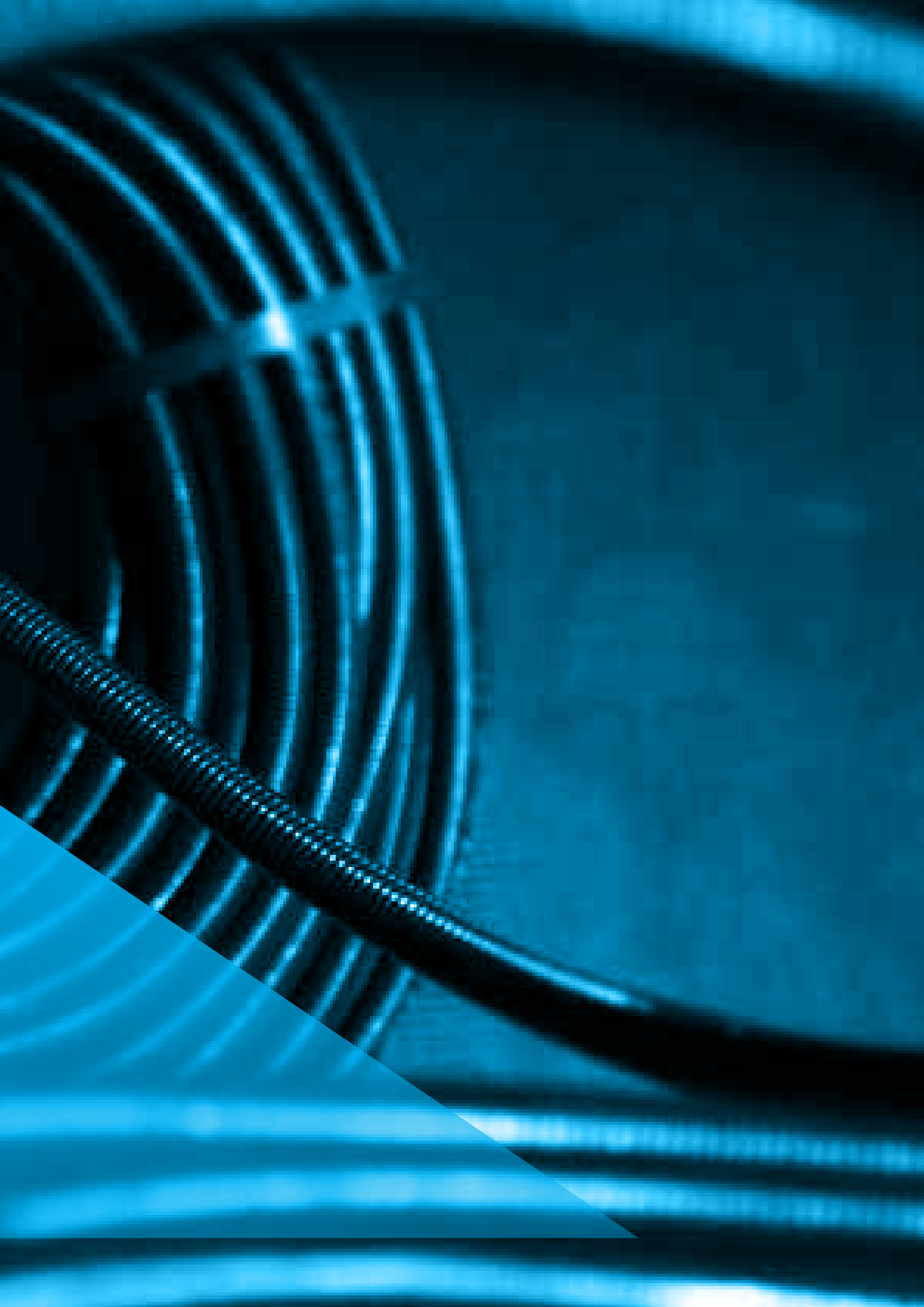



PROTEZIONE CAVI

Cable protection

Tubo corrugato corrugated tube

PA6 HB - PA6 HB

POLYFLEX®

PA6 HB

Profilo normale

POLYFLEX®

PA6 HB

Normal Profile

UL-Nr.:
E81427

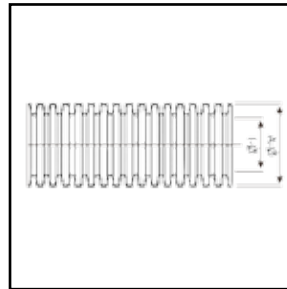

Materiale:

Poliammide 6

Campo di temperatura:

3000 ore: -40°C fino a 120°C
240 ore: -40°C fino a 150°C

Ritardante di fiamma:

- UL 94: HB
- secondo FMVSS 302:
< 100mm/min

Colore/esecuzione:

- Nero, grigio, altre su richiesta
- Lunghezze su richiesta

Caratteristiche:

- No banda di avvolgere necessario per rami e fine dei cavi
- UV-resistente secondo DIN EN ISO 8580
- Libero di alogeno

Campo d'impiego:

- Per alti carichi meccanico
- Vano motore e carrozzeria
- Macchine edile e macchine
- Costruzione navale e ferroviario
- armadi dei comandi

Material:

Polyamide 6

Temperature range:

3000 h: -40°C to 120°C
240 h: -40°C to 150°C

Inflammability:

- UL 94: HB
- acc. to FMVSS 302:
< 100mm/min

Colour(s)/Designs:

- Black, grey, others on request
- Cutted lengths on request

Characteristics:

- No wrapping tape necessary at cable feeders or cable ends
- UV resistant acc. to DIN EN ISO 8580
- Free of halogen

Applications:

- For high mechanical stresses
- Body section and chassis
- Construction machinery and machinery
- Ship- and trainbuilding
- Switch cabinet

DN	Ø A mm	Ø I mm	no. art. intagliato	no. art. non intagliato	UC m	prezzo
NW	Ø A mm	Ø I mm	Art. no slit	Art. no. unslit	PU m	price
4,5	7,1	5,0	014 120 104	014 120 204	100	
6	9,2	6,0	014 120 106	014 120 206	100	
7,5	10,0	6,7	014 120 107	014 120 207	50	
8,5	11,7	8,4	014 120 108	014 120 208	50	
10	13,0	9,9	014 120 110	014 120 210	50	
13	15,8	12,7	014 120 113	014 120 213	50	
17	21,2	16,6	014 120 117	014 120 217	50	
19	24,3	19,3	014 120 119	014 120 219	50	
22	25,4	21,3	014 120 122	014 120 222	50	
26	31,2	25,8	014 120 126	014 120 226	25	
29	34,5	29,0	014 120 129	014 120 229	25	
37	42,4	36,0	014 120 137	014 120 237	25	
50	54,0	47,7	014 120 150	014 120 250	25	

su richiesta
on request

PP - PP

POLYFLEX®

PP

Profilo normale



POLYFLEX®

PP

Normal Profile

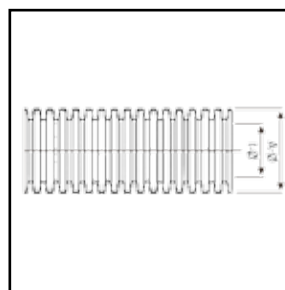

Materiale:
Polipropilene

Campo di temperature:
3000 ore: -40°C fino a 105°C
350 ore: -40°C fino a 135°C

Ritardante di fiamma:
• UL 94: HB
• secondo FMVSS 302:
< 100mm/min

Colore/esecuzione:
• Nero, altre su richiesta
• Lunghezze su richiesta

Caratteristiche:
• Alta resistenza al calore
• Immensa temperatura
 impatto tenacità
• Alta tenacità
• Resistenza alla flessione
• Ottima fermezza chimica
• UV-resistente secondo
 DIN EN ISO 8580

Campo d'impiego:
• Costruzione di autoveicoli
• AHW-Profillo: particolarmente
 adatta per piccoli raggi di
 curvatura

Material:
Polypropylene

Temperature range:
3000 h: -40°C to 105°C
350 h: -40°C to 135°C

Inflammability:
• UL 94: HB
• acc. to FMVSS 302:
< 100mm/min

Colour(s)/Designs:
• Black, others on request
• Cutted lengths on request

Characteristics:
• Great shape permanence to
 heat
• Enourmous cold impact
 strength
• High strength
• Bending stabile
• Excellent chemical resistance
• UV resistant acc. to
 DIN EN ISO 8580

Applications:
• Vehicle Industries
• AHW-Profillo: for small bending
 radil recommended

DN	Ø A mm	Ø I mm	art. no. intagliato	art. no. non intagliato	UC m	prezzo
NW	Ø A mm	Ø I mm	Art. no slit	Art. no. unslit	PU m	price
4,5	7,1	5,0	014 100 104	014 100 204	100	
6	9,2	6,0	014 100 106	014 100 206	100	
7,5	9,9	6,9	014 100 107	014 100 207	50	
8,5	11,6	8,5	014 100 108	014 100 208	50	
10	12,7	10,1	014 100 110	014 100 210	50	
13	15,8	12,9	014 100 113	014 100 213	50	
17	21,0	16,8	014 100 117	014 100 217	50	su richiesta on request
19	24,0	19,4	014 100 119	014 100 219	50	
22	25,5	21,8	014 100 122	014 100 222	50	
26	31,3	26,4	014 100 126	014 100 226	25	
29	33,9	29,3	014 100 129	014 100 229	25	
37	42,0	36,7	014 100 137	014 100 237	25	



PROTEZIONE CAVI

Cable protection

Tubo corrugato corrugated tube

Duo-Flex PA6 HB - Duo-Flex PA6 HB



Duo-Flex PA6 HB

binario + profilo chiudibile



Duo-Flex PA6 HB

two piece + closable Profile

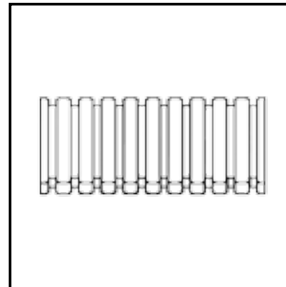
**Materiale:**

Poliammide 6 HB

Campo di temperatura:

3000 ore: -40°C fino a 120°C
240 ore: -40°C fino a 150°C

Ritardante di fiamma:

- UL 94: HB
- Secondo FMVSS 302: <100mm/min

Colore/esecuzione:

- Nero, altre su richiesta
- Lunghezze (taglio su cresta dell'onda) su richiesta
- Container su richiesta

Caratteristiche:

- Bionario
- Divisibile in lunghezza
- chiudibile

- Schlemmer distributore, raccordo per tubo flessibile e accessori utilizzabile
- Immensa temperatura impatto tenacità
- Resistenza alla flessione
- Ottima fermezza chimica

Campo d'impiego:

- Ideale per montaggio ulteriore e riparazione
- Per cartella di cavo nel ufficio e aria privato es. computer, HiFi
- Industria automobilistica
- Costruzione di armadio dei comandi
- Industria elettrodomestici
- Calorifero e aria condizionata
- Industria elettrica
- Costruzione navale e ferroviario
- Industria meccanica

Material:

Polyamide 6 HB

Temperature range:

3000 h: -40°C to 120°C
240 h: -40°C to 150°C

Inflammability:

- UL 94: HB
- Acc. to FMVSS 302: <100mm/min

Colour(s)/Designs:

- Black, others on request
- Cutted lengths (cut on the crest) on request
- Containers on request

Characteristics:

- Two piece
- Longitudinal dividable
- Closable

• Schlemmer Manifolds, Conduit Glands and Accessories usable

- High cold impact strength and ultimate elongation
- Bending stabile
- Excellent chemical resistance

Applications:

- Ideal for retrofit and repair
- As cable organizer for office and private sector e.g. Computer, HiFi
- Automotive Industries
- Switch cabinets
- Household Appliances
- Heating and air conditioning
- Electric Power Industry
- Ship- and train building
- Machines

DN	Ø A mm	Ø I mm	no. art.	UC m	prezzo
NW	Ø A mm	Ø I mm	Art. no	PU m	price
7,5	10,3	5,6	015 129 107	50	
10	13,3	8,5	015 129 110	50	
13	16,0	11,0	015 129 113	50	
17	21,5	15,5	015 129 117	50	
22	25,6	19,1	015 129 122	50	
26	31,7	24,0	015 129 126	25	
29	35,0	27,2	015 129 129	25	
37	42,5	32,0	015 129 137	25	
50	53,9	43,9	015 129 150	25	

su richiesta
on request

chiudibile - lockable

POLYFLEX®

chiudibile

RoHS

POLYFLEX®

lockable

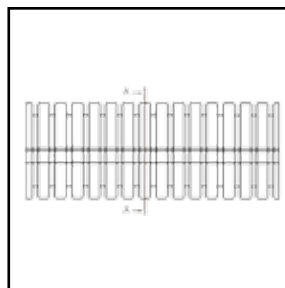

Materiale:

PPmod: Polipropilene modificato
Altre materiali su richiesta

Campo di temperature:

3000 ore: -40°C fino a 135°C
500 ore: -40°C fino a 150°C

Ritardante di flamma:

- Secondo FMVSS 302: autostinguente
- Velocità di combustione 0 secondo DIN 75200

Colore/esecuzione:

- Nero, altre su richiesta
- Lunghezze e Container su richiesta

Caratteristiche:

- Risparmio di peso da minimo DN
- Minimo raggio di curvatura
- No banda di avvolgere necessario per rami e fine dei cavi
- UV-resistente secondo DIN EN ISO 8580
- Chiudere sicuro è solo possibile con trumento di chiusura originale di Schlemmer

Campo d'impiego:

- Autoveicoli e veicoli commerciale
- Vano motore e installazione vicino al motore
- Adatto per installazione posteriore

Material:

PPmod: modified Polypropylene
Further materials on request

Temperature range:

3000 h: -40°C to 135°C
500 h: -40°C to 150°C

Inflammability:

- Acc. to FMVSS 302: selfextinguishing
- Burningrate 0 acc. to DIN 75200

Colour(s)/Designs:

- Black, others on request
- Cutted lengths and Containers on request

Characteristics:

- Reduction in weight by using the smallest NW
- Smallest bending radil
- No wrapping tape necessary at cable feeders or cable ends
- UV resistant acc. to DIN EN ISO 8580
- Process safe locking only by using the original Schlemmer closing tool

Applications:

- Cars and heavy trucks
- Body section and near the engine
- For subsequent assembly

Chiudibile
Lockable

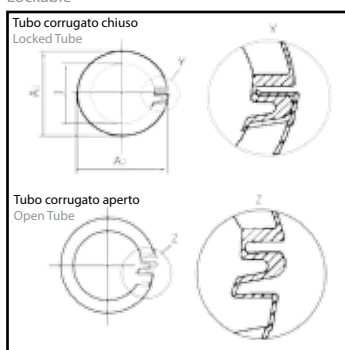

Materiale	DN	UL 94	accessori adatto	Ø A1 mm	Ø A2 mm	Ø l mm	no. art.	prezzo
Material	NW	UL 94	suitable Accessories	Ø A1 mm	Ø A2 mm	Ø l mm	Art. no.	price
PPmod	8,5V	V2	NW 10	12,8	13,3	8,6	014 147 708	
PPmod	11V	V2	NW 13	15,7	16,3	11,2	014 147 711	
PPmod	13V	V2	-	18,3	18,9	12,2	014 147 713	su richiesta on request
PPmod	15V	V2	NW 17	21,3	22,0	14,9	014 147 715	
PPmod	19V	V2	NW 22	25,6	26,2	19,0	014 147 719	
PPmod	26V	V2	NW 26	31,5	32,0	24,6	014 147 726	



Tubo corrugato speciale e accessori Lei trova al nostro catalogo per tubo corrugato o in linea!
Special corrugated tubes and equipment you will find in our product catalogue for corrugated pipes or online!



PROTEZIONE CAVI

Cable protection

Accessori accessories

Clip di fissaggio - retaining clip

Clip di fissaggio

retaining clip

nero

black

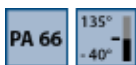

Materiale:
Poliamide 66

Campo d'impiego:
• di fissare i tubi corrugati o
cablaggi per carrozzeria

Campo di temperatura:
240 h/150°C

Material:
Polyamide 66

Applications:
• for fixation of
corrugated pipes or
cable harness on auto body

Caratteristiche:
• montaggio flessibile
• collegamento ottimale per tubi
corrugati

Top operating temperature:
240 h/150°C

Characteristics:
• flexible mountable
• optimal access for
corrugated tubes

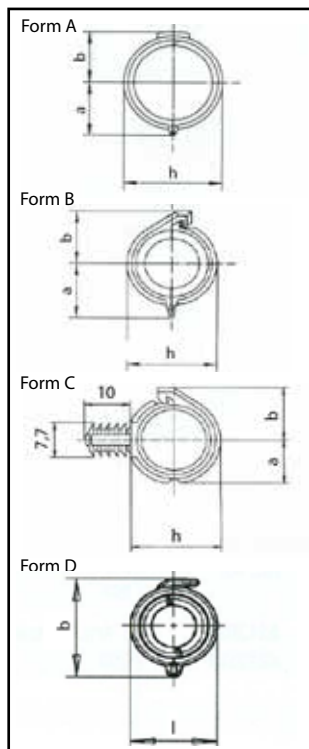

Form	per DN profilo normale	per DN AHW	h mm	b mm	l mm	no. art.	UC pezzi	Precio
form	for NW normal profile	for NW AHW	h mm	b mm	l mm	art. no.	PU unit	price
A	4,5	4,5		13,0	9,4	014 200 004	100	
A	7,5	6		15,8	12,2	014 200 007	100	
A	10	8,5		18,9	15,4	014 200 010	100	
A	13	11		21,6	18,3	014 200 013	100	su richiesta on request
A	14			24,6	21,3	014 200 014	100	
A	17	15		27,1	23,6	014 200 017	100	
A	22	19		31,6	28,3	014 200 022	100	
A	26	26		37,7	34,4	014 200 026	100	
B	8,5			18,3	15,6	014 200 508	100	su richiesta on request
B	23S					014 200 523	100	
C	4,5	4,5	10,2	5,5	7,2	014 200 604	100	
C	7,5	6	13,2	7,0	8,7	014 200 607	100	
C	8,5		14,7	7,8	9,5	014 200 608	100	
C	10	8,5	15,8	8,3	10,0	014 200 610	100	su richiesta on request
C	13	11	19,0	10,0	11,7	014 200 613	100	
C	17	15	24,0	12,0	14,0	014 200 617	100	
C	22	19	28,4	14,6	16,2	014 200 622	100	
D	17	15		27,4	23,8	014 200 717	100	su richiesta on request
D	22	19		31,9	28,3	014 200 722	100	

Fascette - cable ties

Fascette

Cable ties

nero

black



Materiale:
Poliamide 6.6

Caratteristiche:

- SKB: Fascette chiudibile per sé
- Resistente agli oli , benzina , acqua salata , solventi , alcali
- Stabilizzato UV

Campo di temperatura:
-40°C bis +60°C

Material:
Polyamide 6.6

Temperature range:
-40°C to +60°C

Ritardante di fiamma:
UL 94: V2

Inflammability:
UL 94: V2

Colore/esecuzione:
nero

Colour/execution:
black

Characteristics:

- SKB: self lock tie
- Resistant against: Oils, petrols, saltwater, sulfids, alkalis
- UV-stabilized

Tipo type	misure l x b mm dimensions l x b mm	per max. Ø for max. Ø	min. resistenza alla trazione kg min. tensile strength kg	no. art. art. no.	no. di riferimento reference no.	UC pezzi PU pcs.	Precio price
SKB 100 x 2,5	100 x 2,5	24,0	11,0	042 025 100	8330200	100	
SKB 200 x 2,5	200 x 2,5	55,0	11,0	042 025 200	8330203	100	
SKB 300 x 4,5	300 x 4,5	82,0	28,0	042 045 300	8330215	100	
SKB 360 x 4,5	360 x 4,5	101,0	28,0	042 045 360	8330216	100	
SKB 430 x 4,5	430 x 4,5	123,0	28,0	042 045 430	8330217	100	
SKB 360 x 7,5	360 x 7,5	101,0	65,0	042 075 360	8330221	100	
SKB 550 x 9,0	550 x 9,0	160,0	80,0	042 090 550	8330225	100	

su richiesta
on request

Officina allestimento

Questo gruppo di prodotti include 220/240 V estensione e distributore ecc.
Sviluppiamo e produciamo variante customizzato.

FACTORY EQUIPMENT

This product line includes 220/240 V extensions and distributor etc.
We generate and manufacture custom-specific variations.





230/400 V 230/400 V

Distributore per corrente trifase - three-phase current distributor



Distributore per corrente trifase IP44 400V/16A con 1x CEE-spina, 2x CEE-prese e 1x SchuKo-presa non sicuro.

Three-phase current distributor IP44 400V/16A with 1x CEE-plug, 2x CEE-sockets and 1x SchuKo plug socket unsecured.

Art. - Nr. Art. no.	Preis price
224 435 502	su richiesta on request

SchuKo-distributore - SchuKo-distributor



Distributore di presa IP44 230V/16A con 4x SchuKo-prese e arpione di metallo pieghevole.

Socket distributor IP44 230V/16A with 4x SchuKo plug and retractable metal hook.

no. art. Art. no.	prezzo price
224 065 402	su richiesta on request

SchuKo-distributore - SchuKo-distributor



Distributore di plastica mobile IP44 230V/16A con archetto, 1x M20 collegamento a vite e 3x SchuKo-presa non sicuro.

Mobile plastic distributor IP44 230V/16A with bracket, 1x M20 bolting and 3x SchuKo plug socket unsecured.

no. art. Art. no.	lunghezza length	prezzo price
224 045 302	1,5 m	su richiesta on request

SchuKo-distributore - SchuKo-distributor



Frizione pendente di gomma IP54 230V con 3 volte calotta apribile e gancio di traino.

Solid rubber-hang up coupling IP54 230V with triple hinged lids and hitch.

no. art. Art. no.	lunghezza length	prezzo price
224 040 302	1,5 m	su richiesta on request

SchuKo-spina - SchuKo-plug

Spina per protezione di cavi gomma giallo o rosso, 230 V/AC, 16 A.

Safety plug gum yellow or red, 230V/AC, 16A.



no. art. Art. no.	colore colour	prezzo price
224 006 201	giallo yellow	su richiesta on request
224 003 201	rosso red	

SchuKo-presa - SchuKo-socket

Presa per protezione di cavi gomma giallo o rosso, 230V/AC, 16 A.

Safety plug gum yellow or red, 230V/AC, 16A.

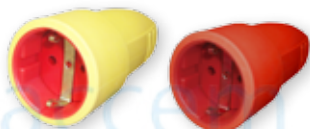

no. art. Art. no.	colore colour	prezzo price
224 006 202	giallo yellow	su richiesta on request
224 003 202	rosso red	

Prolunga - extension

Prolunga per la cantiere 230V con spina per protezione di gomma. Resistente fino a 3500 Watt.

Road works extension cable 230V with gum-contact plug. Up to 3500 watt resilient.



no. art. Art. no.	lunghezza length	sezione cross-section	prezzo price
224 063 151	10 m	3 x 1,5 mm ²	su richiesta on request
224 063 155	25 m	3 x 1,5 mm ²	
224 063 252	50 m	3 x 1,5 mm ²	

Prolunga - extension

Prolunga per la cantiere 230V con presa per protezione di gomma. Resistente fino a 3500 Watt.

Road works extension cable 230V with gum-contact plug. Up to 3500 watt resilient.



no. art. Art. no.	lunghezza length	sezione cross-section	prezzo price
224 066 151	10 m	3 x 1,5 mm ²	su richiesta on request
224 066 155	25 m	3 x 1,5 mm ²	
224 066 252	50 m	3 x 1,5 mm ²	



PIANO DI OCCUPAZIONE

assignment charts

24 Volt - 7-poli - 24 Volt - 7-pole

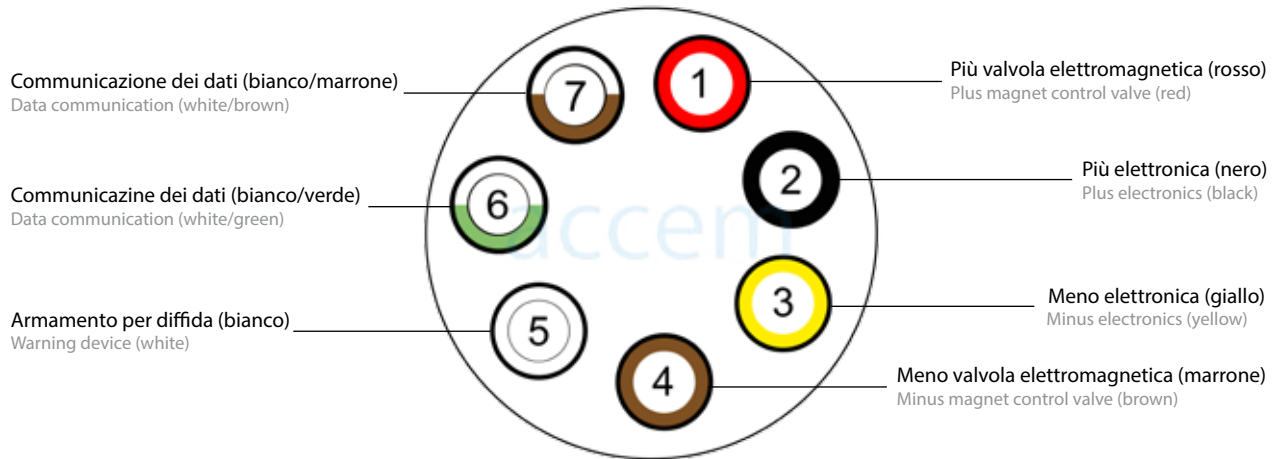

24 Volt - 15-poli - 24 Volt - 15-pole

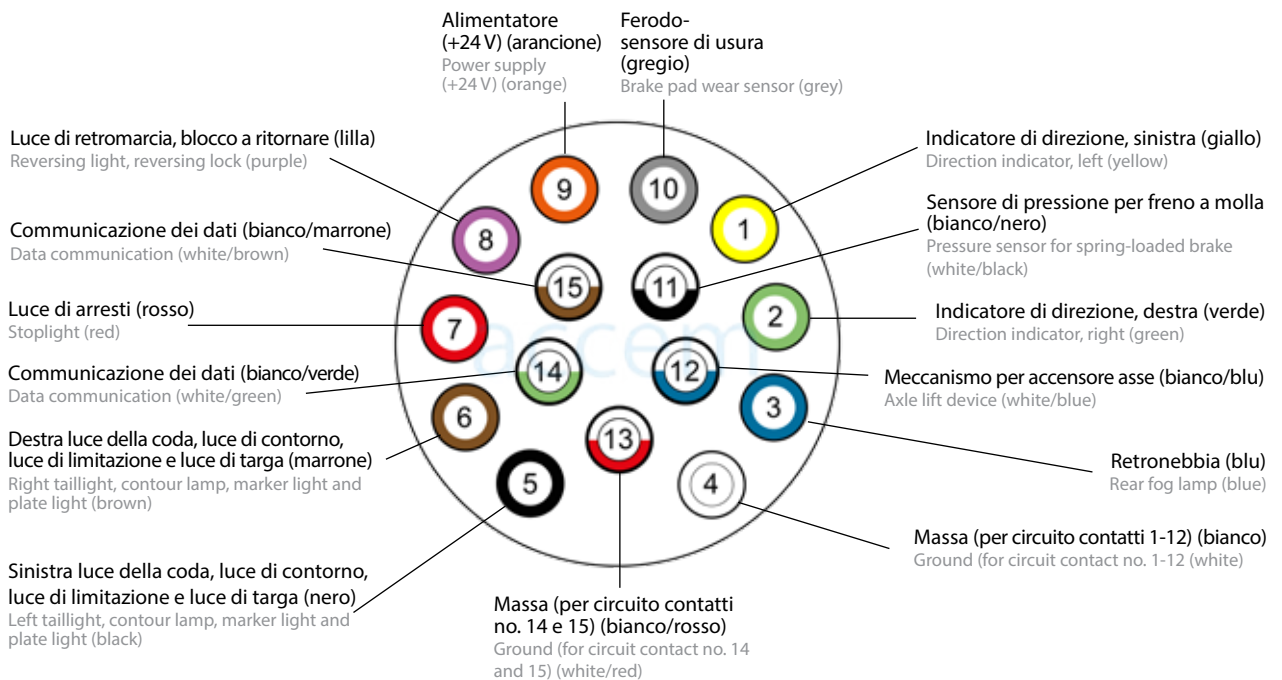

24 Volt - 7-poli tipo S - 24 Volt - 7-pole type S

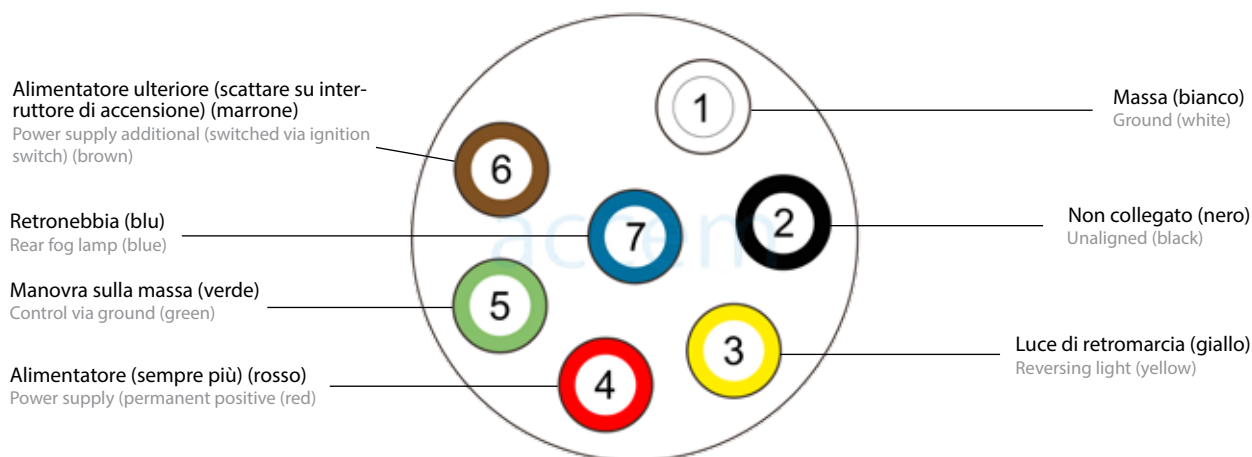

24 Volt - 7-poli tipo N - 24 Volt - 7-pole type N



Tabella dei componenti codice IP (stralcio)

Overview of the IP-Code parts (excerpt)

I tipi di protezione essere specificato per un simbolo, che composto del lettere di codice IP sempre invariabile (International Protection) e due seguenti numeri distintivi per i gradi di protezione. Il primo numero di codice indica il grado di protezione da toccata e corpo estraneo, il secondo numero di codice il grado di protezione contro infiltrazione nociva di acqua.

The protection categories are named by a short symbol which are made up of always constant code letters IP (International Protection) and two following code digits for the degree of protection. The first code digit indicates the protection against contact and foreign bodies, the second code digit indicates the degree of protection against the ingress of moisture.

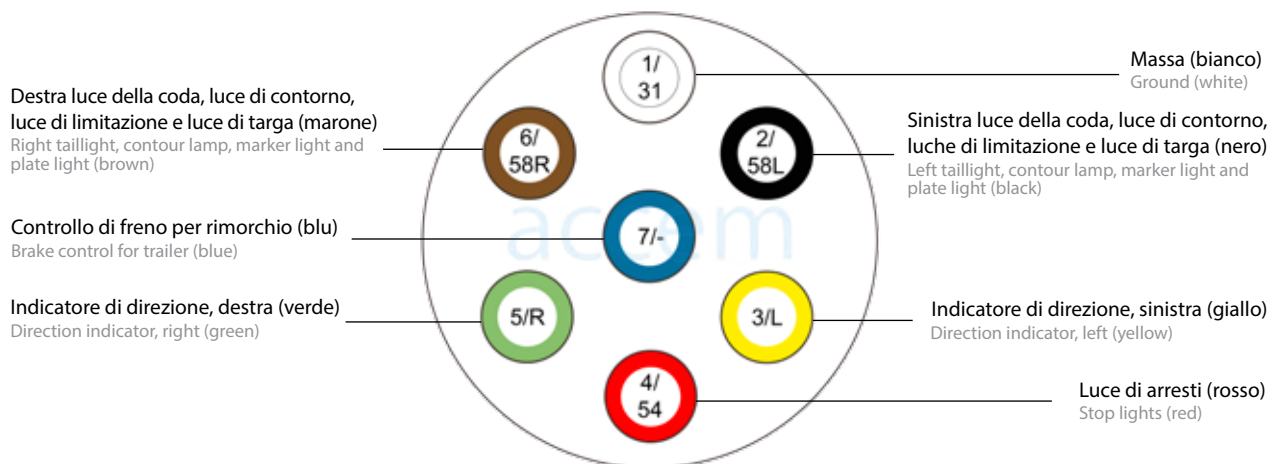
1. numero di codice first key figure	Protezione contro toccare da persone protection against contact by persons	Protezione contro infiltrazione di corpi estranei solidi protection against ingress of solid foreign bodies	2. numero di codice second key figure	Protezione contro infiltrazione di acqua protection against ingress of water
0 0	non protetto unprotected	non protetto unprotected	0 0	non protetto unprotected
1 1	con il dorso della mano with the back of the hand	oggetto con Ø più di 50 mm object with Ø over 50 mm	1 1	gocciare verticale vertical drop
2 2	con il dito with the finger	oggetto con Ø più di 12,5 mm object with Ø over 12,5 mm	2 2	goccia a pendenza di 15° drop at 15° inclination
3 3	con attrezzi with tools	oggetto con Ø più di 2,5 mm object with Ø over 2,5 mm	3 3	acqua nebulizzata spray water
4 4	con filo sottile with thin conductor	oggetto con Ø più di 1 mm object with Ø over 1 mm	4 4	acqua spruzzato splash water
5 5	con filo sottile with thin conductor	protetto contro la polvere dust-protected	4 K 4 K	acqua spruzzato, sotto pressione rialzata, solo per veicoli stradale splash water, under increased pressure, only for road vehicle
6 6	completamente completely	a tenuta di polvere dust-tight		
			5 5	acqua irradiata hose water
			6 6	acqua irradiata forte powerful hose water
			6 K 6 K	acqua irradiata forte, sotto pressione rialzata, (allagamento), solo per veicoli stradale powerful hose water, under increased pressure (flooding), only for road vehicle
			7 7	immersione temporanea temporarily immersion
			8 8	immersione continua permanently immersion
			9 K 9 K	per abluzione con pressione forte o di vapore solo per veicoli stradale at high pressure-/steam jet cleaning, only for road vehicle



Note legali

Legal notices

Tutte le nostre offerte previde sono non validi con questo catalogo. Un contratto é solo valido come concluso, che affermiamo per scritto la accettazione del ordine. Le condizione di forniture e vendite attuale sono valido per tutte le forniture. Il nostro catalogo é solo definito per il settore commerciale.

Miglioramenti e cambiamenti al tipo di costruzione o esecuzione stiano riservato a noi. I prezzi sono adeguati annualmente su quotazioni metalli. Ci riserviamo tuttavia esplicita, di fare allineamento dei prezzi da cambiamenti significativi durante l'anno civile cor-

rente. Non c'è una garanzia accordo competo delle illustrazione con il prodotto. Risarcimenti per causa di errore di stampa eventuale o informazione incompiuta diventano esclusi.

Piante, bozzette, altri documenti tecnici, campioni, cataloghi, prospetti, illustrazione, preventivi delle spese, disegni o altri documenti di offerta restariano sempre la proprietà intellettuale della azienda accem-Automotive GmbH.

Ci riserviamo tutti i diritti ai documenti. Senza il nostro consenso questi possono né riprodotto né inoltrato. I prodotti da noi forniti devono essere

forniti esclusivamente per lo scopo previsto e possono essere installati solo da personale qualificato .

All our previous offers are invalid with this catalogue. A contract is only closed if we confirm the receipt of the order in written form. For all our deliveries apply the current conditions of sale and delivery. Our catalogue is only ment for the commercial sector.

We reserve the right to improvements and modifications of the building class. The prices will be adjusted annually to the metal quotation. We reserve however the right to change prices during

the calendar year if there are significant changes. We grant no guarantee for the complete accordance of the illustration with the product. Compensations because of eventually misprints or incomplete indications are excluded.

Plans, drafts or other technical documents, samples, catalogues, brochures or illustrations as well as quotations, paintings or other bidding documents stay always intellectual property of the company accem-Automotive GmbH.

We reserve all the rights of the documents. Without our approval it isn't allowed to duplicate or to transmit these documents. Products which are delivered of us are only for normal use and may only be installed of expert staff.



accem - Automotive GmbH

Maderspergerstraße 10
A-4560 Kirchdorf/Krems
Tel. +43 7582 / 61 219 - 0
Fax +43 7582 / 61 219 - 30
E-mail: office@accem.at



accem - Automotive GmbH

Vertriebspartner gesucht
Nous recherchons des distributeurs
Tel. +43 7582 / 61 219 - 0
Fax +43 7582 / 61 219 - 30
E-mail: office@accem.at

Marketing und Entwicklung

Ramsau 29
A-4591 Molln
Tel. +43 7582 / 61 219 - 10
Fax +43 7582 / 61 219 - 30
E-mail: office@accem.at



accem - Automotive GmbH

Vertriebspartner gesucht
Buscando distribuidores
Tel. +43 7582 / 61 219 - 0
Fax +43 7582 / 61 219 - 30
E-mail: office@accem.at



Mazucchelli S.r.l.

Via Sansovino, 243/65/T
10151 Torino (TO) - Italia
Tel. +39 011 4532064
Fax +39 011 4540930
E-mail: commerciale@maz.it
www.maz.it



accem - Automotive GmbH

Vertriebspartner gesucht
Looking for distribution partner
Tel. +43 7582 / 61 219 - 0
Fax +43 7582 / 61 219 - 30
E-mail: office@accem.at



accem - Automotive GmbH

Vertriebspartner gesucht
Tel. +43 7582 / 61 219 - 0
Fax +43 7582 / 61 219 - 30
E-mail: office@accem.at



accem - Automotive GmbH

Vertriebspartner gesucht
Jälleenmyyjät halusi
Tel. +43 7582 / 61 219 - 0
Fax +43 7582 / 61 219 - 30
E-mail: office@accem.at



accem - Automotive GmbH

Vertriebspartner gesucht
Tel. +43 7582 / 61 219 - 0
Fax +43 7582 / 61 219 - 30
E-mail: office@accem.at



accem - Automotive GmbH

Vertriebspartner gesucht
Distributörer ville
Tel. +43 7582 / 61 219 - 0
Fax +43 7582 / 61 219 - 30
E-mail: office@accem.at