

Catálogo General

Main Catalogue

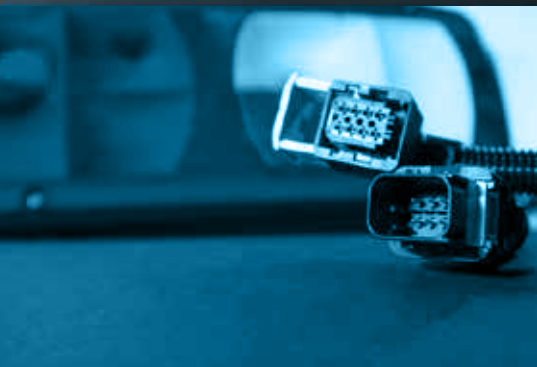

Juego de cables disponible en 24 horas desde fábrica Cable sets in 24 hours ex works





Para una eficiencia en los costes y el cumplimiento de las normas internacionales y los estándares de calidad, resulta útil la integración de todos los proveedores del sistema en las etapas iniciales del proyecto. De acuerdo a sus necesidades atendemos sus proyectos desde el concepto del producto hasta su producción. En nuestra fábrica

con base en Kirchdorf an der Krems, producimos mazos de cables de seguridad en serie y cables especiales de forma individual, siguiendo todas las normas de calidad internacionales y estándares. Debido a la flexibilidad de nuestra empresa, podemos hacer paradas en la producción y modificaciones continuamente en la producción en se-

rie, de forma muy rápida y económica. Usamos nuestros amplios contactos y experiencia profesional con diferentes suministradores de componentes. Para una perfecta relación fabricante-proveedor, ofrecemos un catálogo completo de nuestros productos disponibles para la venta.

To guarantee cost efficiency, compliance of international norms and quality standards it is useful to integrate the system supplier in a very early stage of the project. Definitive environmental awareness, cost reduction and optimisation of assembly at simultaneously increase of quality are the strength of our team. We take care for your project

according to your needs from concept to production. In our manufacturing base in Kirchdorf we make serial cable harnesses and special harnesses with individual marking according to international standards and norms. Due to the flexibility of the company we can realise start-ups of production and changes in

running serial production very quick. Of course we are using most modern machines and Automation. Use our contacts and experience to various international single part suppliers. To perfect the relation Manufacturer – Supplier we offer the complete material program of our wide business area also for sale.



Envío ordinario

Austria: 1-2 días
Europa: 2-3 días

Envío Express

Austria y Alemania:
Garantizado desde las 12:00 del día siguiente.
Disponible envíos en Sábado

Standard shipping

Austria: 1-2 days
Europe: 2-3 days

Express shipping

Austria and Germany:
Guaranteed delivery until 12:00 next day.
Saturday delivery possible

Alumbrado parte trasera
taillights



NEU

página /page 6

Alumbrado lateral
side-marker lamps



página /page 28

ABS, EBS, 15 polos, N/S
ABS, EBS, 15-pole, N/S



página /page 44

NATO
nato



página /page 54

Otros juego de cables
various cable sets



página /page 64

Productos por encargo
special design

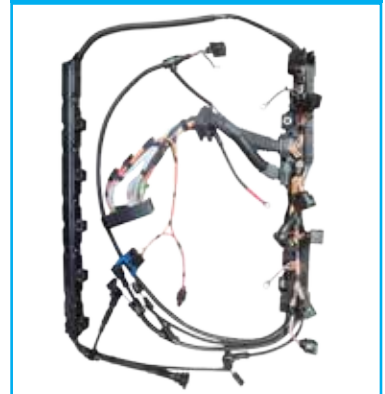

página /page 69

Protección para cables
cable protection



página /page 72

Taller equipamiento
factory equipment



página /page 80

Información técnica
technical information

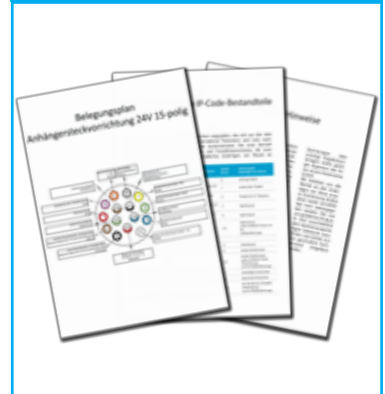

página /page 84

Lista de fabricante de vehículo vehicle manufacturer register

adaptado para vehículo fits for vehicle	Prolongadores alumbrado parte trasera extension taillight	Prolongadores alumbrado lateral extension side marker lamp	Prolongadores luz matrícula extension plate light
DAF	p. 8, 9, 10, 11	p. 36, 37	p. 10, 11
DAF ab BJ 2013	p. 18, 19	p. 36, 37	S. 19
DAF XF	p. 24	p. 36, 37	
para div. Proplast		p. 36, 37	
para div. ULO		p. 43	
para div. Vignal		p. 34, 35	
Ford Transit	p. 25		
IVECO Daily	p. 12, 13, 14, 15	p. 38, 39	p. 14, 15, 67
IVECO Stralis	p. 22, 23, 24	p. 40, 41	p. 22, 23
IVECO Stralis Euro 6	p. 20, 21, 22, 23	p. 40, 41	p. 22, 23
IVECO Trakker Euro 6	p. 20, 21, 22, 23		p. 22, 23
IVECO Eurocargo Euro 6	p. 20, 21, 22, 23	p. 42	p. 22, 23
MAN TG	p. 8, 9, 10, 11	p. 30, 31	S. 10, 11
MAN 2000	p. 20, 21, 22, 23	p. 30, 31	p. 22, 23
Mercedes Benz	p. 12, 13, 14, 15	p. 32, 33	p. 14, 15
MB Actros a partir de 2012	p. 16, 17	p. 32, 33	p. 17
MB Antos a partir de 2012	p. 16, 17	p. 32, 33	p. 17
MB Atego	p. 20, 21, 22, 23	p. 32, 33	p. 22, 23
MB Atego a partir de 2013	p. 16, 17	p. 32, 33	p. 17
MB Sprinter	p. 12, 13, 14, 15	p. 43	p. 14, 15
Mitsubishi	p. 12, 13, 14, 15		p. 14, 15
Nissan Alteo Cabstar	p. 12, 13, 14, 15		p. 14, 15
Renault	p. 8, 9, 10, 11	p. 36, 37	p. 10, 11
Scania	p. 8, 9, 10, 11	p. 32, 33	p. 10, 11
Volvo	p. 8, 9, 10, 11	p. 32, 33	p. 10, 11
VW Crafter	p. 12, 13, 14, 15		p. 14, 15



adaptado para vehiclu	Válvulas, sensores y medidor nel nivel de combustible	Cable adaptador para alumbrado parte trasera	Varios
fits for vehicle	tank encoder, sensors, etc.	adapercable for taillight	others
DAF			
DAF ab BJ 2013			
DAF XF			
para div. Proplast			
para div. ULO			
para div. Vignal			
Ford Transit		p. 27	
IVECO Daily	p. 66	p. 27	
IVECO Stralis			
IVECO Stralis Euro 6			
IVECO Trakker Euro 6			
IVECO Eurocargo Euro 6			
MAN TG	p. 66	p. 26	p. 25
MAN 2000			
Mercedes Benz		p. 26	
MB Actros a partir de 2012			
MB Antos a partir de 2012			
MB Atego			
MB Atego a partir de 2013			
MB Sprinter	p. 66		
Mitsubishi			
Nissan Alteo Cabstar			
Renault			
Scania			
Volvo			
VW Crafter			

Alumbrado parte trasera Prolongadores

Este grupo de productos incluye prolongadores, cables de conexión y prolongadores en Y.
Nosotros podemos realizar variaciones específicas a petición.

TAILLIGHTS - EXTENSIONS

This product line includes extensions, connecting cables and Y-extensions.
We generate and manufacture custom-specific variations.

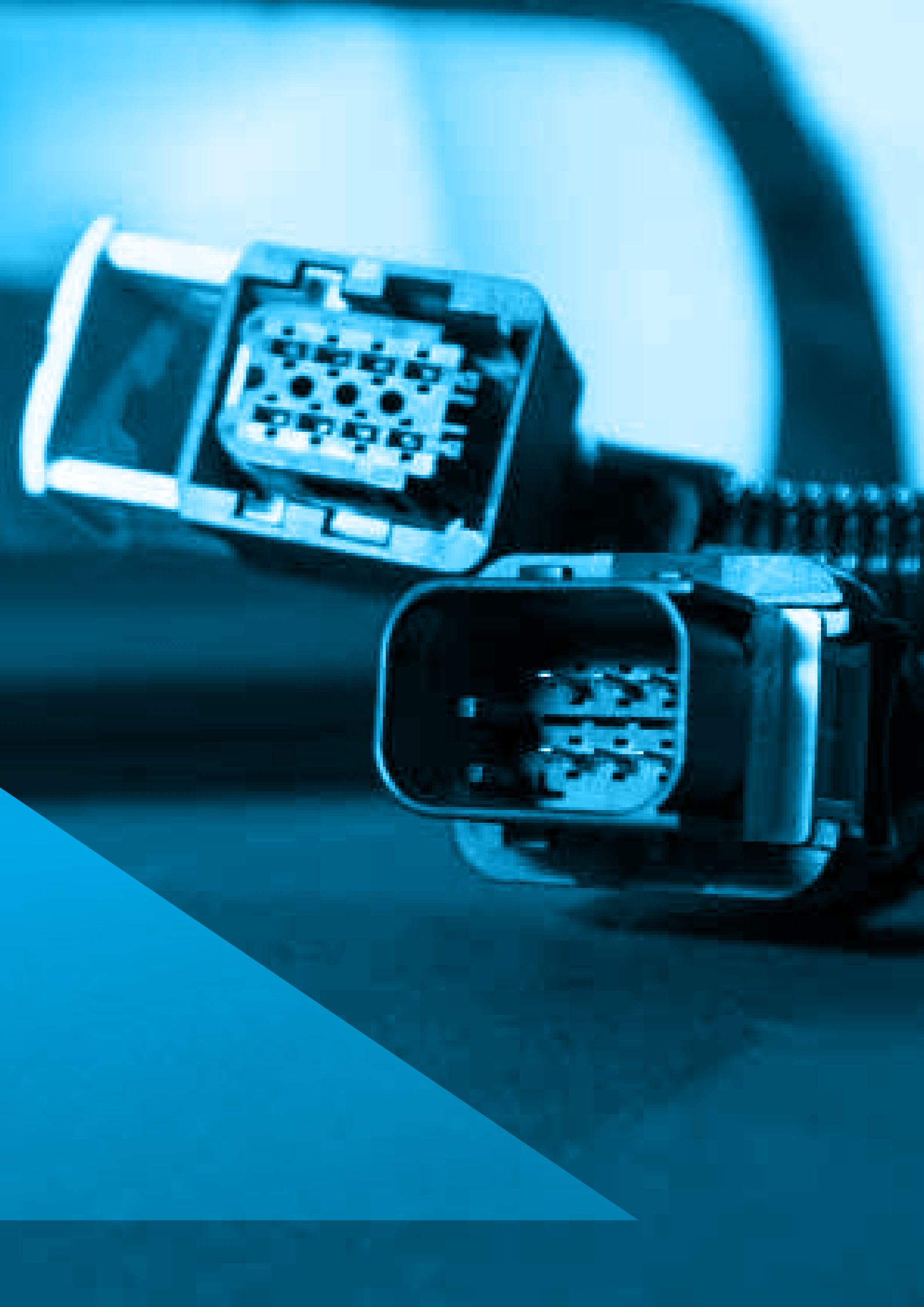



ALUMBRADO PARTE TRASERA

Taillights

adaptado para (fits for) MAN, Scania, DAF, Renault, Volvo

7 polos prolongadores 90° - 7-pole extension 90°



Cable alargador de 7 polos 24V disponible para luces traseras de la parte derecha e izquierda. Adaptador 90° / 180°. Otras longitudes disponibles a petición.

7-pole extension 24 V fits for the left and the right taillight. Adapter 90° / 180°. Further lengths on request.

adaptado para fits for	Art. - No. Art. no.	Referencia No. comparison no.	Longitud length	Precio price	
	083 100 100		1000 mm		
MANTG	083 100 160	81.25428-6982	81254286982	1600 mm	a petición on request
	083 100 200	82.28611-0002	82286110002	2000 mm	
	083 100 250	81.25458-6500	81254586500	2500 mm	
Scania	083 700 100		1000 mm		
	083 700 160		1600 mm	a petición on request	
	083 700 200		2000 mm		
	083 700 250		2500 mm		
DAF	083 800 100		1000 mm		
	083 800 160		1600 mm	a petición on request	
	083 800 200		2000 mm		
	083 800 250		2500 mm		
Renault	083 900 100		1000 mm		
	083 900 160		1600 mm	a petición on request	
	083 900 200		2000 mm		
	083 900 250		2500 mm		
Volvo	183 400 100		1000 mm		
	183 400 160		1600 mm	a petición on request	
	183 400 200		2000 mm		
	183 400 250		2500 mm		

7 polos prolongadores 180° - 7-pole extension 180°



Cable alargador de 7 polos 24 V disponible para las luces traseras derecha e izquierda. Adaptador 2 x 180°. Otras longitudes disponibles a petición.

7-pole extension 24 V fits for the left and the right taillight. Adapter 2 x 180°. Further lengths on request.

adaptado para fits for	Art. - No. Art. no.	Referencia No. comparison no.	Longitud length	Precio price	
MAN TG	083 188 100	81.25428-6975	81254286975	1000 mm	a petición on request
	083 188 160			1600 mm	
	083 188 200			2000 mm	
	083 188 250			2500 mm	
Scania	083 788 100			1000 mm	a petición on request
	083 788 160			1600 mm	
	083 788 200			2000 mm	
	083 788 250			2500 mm	
DAF	083 888 100			1000 mm	a petición on request
	083 888 160			1600 mm	
	083 888 200			2000 mm	
Renault	083 888 250			2500 mm	a petición on request
	083 988 100			1000 mm	
	083 988 160			1600 mm	
	083 988 200			2000 mm	
Volvo	083 988 250			2500 mm	a petición on request
	183 488 100			1000 mm	
	183 488 160			1600 mm	
	183 488 200			2000 mm	
	183 488 250			2500 mm	



ALUMBRADO PARTE TRASERA

Taillights

adaptado para (fits for) MAN, Scania, DAF, Renault, Volvo

7 polos prolongadores 90° + luz matrícula - 7-pole extension 90° + plate light



Cable alargador de 7 polos 24 V con una salida para las luces de limitación (58).

Opcional:

- Una salida para las 3. luces de peno (54): (Art.-No. + "B") p.ej.: 083 332 162 B
- Una salida para la luz de matrícula (Art.-No. + "K") p.ej.: 083 322 162 K

Adaptador 90° / 180°. Otras longitudes disponibles a petición.

7-pole extension 24 V with a leaving for a side light (58).

optional:

- For a leaving 3. stop light (54): (art.-no. + "B") e. g. 083 332 162 B
- For a leaving plate light: (art.-no. + "K") e. g. 083 322 162 K

Adapter 90° / 180°. Further lengths on request.

adaptado para fits for	Art. - No. Art. no.	Referencia No. comparison no.	Lungitud length	Ejecución execution	Precio price
MAN TG	083 132 162		1600 mm	2 x 1,0 mm² cable redondo	a petición on request
	083 132 202		2000 mm	2 x 1,0 mm² round cable	
	083 135 162		1600 mm	2 x 1,5 mm² Aspöck P&R	
	083 135 202		2000 mm	2 x 1,5 mm² Aspöck P&R	
Scania	083 732 162		1600 mm	2 x 1,0 mm² cable redondo	a petición on request
	083 732 202		2000 mm	2 x 1,0 mm² round cable	
	083 735 162		1600 mm	2 x 1,5 mm² Aspöck P&R	
	083 735 202		2000 mm	2 x 1,5 mm² Aspöck P&R	
DAF	083 832 162		1600 mm	2 x 1,0 mm² cable redondo	a petición on request
	083 832 202		2000 mm	2 x 1,0 mm² round cable	
	083 835 162		1600 mm	2 x 1,5 mm² Aspöck P&R	
	083 835 202		2000 mm	2 x 1,5 mm² Aspöck P&R	
Renault	083 932 162		1600 mm	2 x 1,0 mm² cable redondo	a petición on request
	083 932 202		2000 mm	2 x 1,0 mm² round cable	
	083 935 162		1600 mm	2 x 1,5 mm² Aspöck P&R	
	083 935 202		2000 mm	2 x 1,5 mm² Aspöck P&R	
Volvo	183 432 032		300 mm		a petición on request
	183 432 162		1600 mm	2 x 1,0 mm² cable redondo	
	183 432 202		2000 mm	2 x 1,0 mm² round cable	
	183 435 032		300 mm		
	183 435 162		1600 mm	2 x 1,5 mm² Aspöck P&R	
	183 435 202		2000 mm	2 x 1,5 mm² Aspöck P&R	

7 polos prolongadores 180° + luz matrícula - 7-pole extension 180° + plate light

Cable alargador de 7 polos 24 V con una salida para las luces de limitación (58).

Opcional:

- Una salida para las 3. luces de peno (54): (Art.-No. + "B") p.ej.: 083 332 162 B
- Una salida para la luz de matrícula (Art.-No. + "K") p.ej.: 083 322 162 K











Adaptador 2 x 180°. Otras longitudes disponibles a petición.

7-pole extension 24 V with a leaving for a side light (58).

optional:

- For a leaving 3. stop light (54): (art.-no. + "B") e. g. 083 332 162 B
- For a leaving plate light: (art.-no. + "K") e. g. 083 322 162 K

Adapter 2 x 180°. Further lengths on request.

adaptado para fits for	Art. - No. Art. no.	Referencia No. comparison no.	Longitud length	Ejecución execution	Precio price
MANTG	083 142 162		1600 mm	 2 x 1,0 mm ² cable redondo 2 x 1,0 mm ² round cable	a petición on request
	083 142 202		2000 mm		
	083 145 162		1600 mm	 2 x 1,5 mm ² Aspöck P&R 2 x 1,5 mm ² Aspöck P&R	
	083 145 202		2000 mm		
Scania	083 742 162		1600 mm	 2 x 1,0 mm ² cable redondo 2 x 1,0 mm ² round cable	a petición on request
	083 742 202		2000 mm		
	083 745 162		1600 mm	 2 x 1,5 mm ² Aspöck P&R 2 x 1,5 mm ² Aspöck P&R	
	083 745 202		2000 mm		
DAF	083 842 162		1600 mm	 2 x 1,0 mm ² cable redondo 2 x 1,0 mm ² round cable	a petición on request
	083 842 202		2000 mm		
	083 845 162		1600 mm	 2 x 1,5 mm ² Aspöck P&R 2 x 1,5 mm ² Aspöck P&R	
	083 845 202		2000 mm		
Renault	083 942 162		1600 mm	 2 x 1,0 mm ² cable redondo 2 x 1,0 mm ² round cable	a petición on request
	083 942 202		2000 mm		
	083 945 162		1600 mm	 2 x 1,5 mm ² Aspöck P&R 2 x 1,5 mm ² Aspöck P&R	
	083 945 202		2000 mm		
Volvo	183 442 032		300 mm	 2 x 1,0 mm ² cable redondo 2 x 1,0 mm ² round cable	a petición on request
	183 442 162		1600 mm		
	183 442 202		2000 mm		
	183 445 032		300 mm	 2 x 1,5 mm ² Aspöck P&R 2 x 1,5 mm ² Aspöck P&R	
	183 445 162		1600 mm		
	183 445 202		2000 mm		



ALUMBRADO PARTE TRASERA

Taillights

adaptado para (fits for) IVECO, Mercedes Benz, VW, Nissan, Mitsubishi

7 polos prolongadores 90° - 7-pole extension 90°



Cable alargador de 7 polos 24 V disponible para las luces traseras derecha e izquierda. Adaptador 90° / 180°. Otras longitudes disponibles a petición.

7-pole extension 24 V fits for the left and right taillight. Adapter 90° / 180°. Further lengths on request.

adaptado para fits for	Art. - No. Art. no.	Referencia No. comparison no.	Longitud length	Precio price
IVECO Daily	083 300 100		1000 mm	a petición on request
	083 300 160		1600 mm	
	083 300 200		2000 mm	
	083 300 250		2500 mm	
Mercedes Benz	083 500 100		1000 mm	a petición on request
	083 500 160		1600 mm	
	083 500 200		2000 mm	
	083 500 250		2500 mm	
VW Crafter	183 100 100		1000 mm	a petición on request
	183 100 160		1600 mm	
	183 100 200		2000 mm	
	183 100 250		2500 mm	
Nissan Alteo Cabstar	183 300 100		1000 mm	a petición on request
	183 300 160		1600 mm	
	183 300 200		2000 mm	
	183 300 250		2500 mm	
Mitsubishi	183 200 100		1000 mm	a petición on request
	183 200 160		1600 mm	
	183 200 200		2000 mm	
	183 200 250		2500 mm	

7 polos prolongadores 180° - 7-pole extension 180°



Cable alargador de 7 polos 24 V disponible para las luces traseras derecha e izquierda. Adaptador 2 x 180°. Otras longitudes disponibles a petición.

7-pole extension 24 V fits for the left and right taillight. Adaptrre 2 x 180°. Further lengths on request.

adaptado para fits for	Art. - No. Art. no.	Referencia No. comparison no.	Longitud length	Precio price
IVECO Daily	083 388 100		1000 mm	a petición on request
	083 388 160		1600 mm	
	083 388 200		2000 mm	
	083 388 250		2500 mm	
Mercedes Benz	083 588 100		1000 mm	a petición on request
	083 588 160		1600 mm	
	083 588 200		2000 mm	
	083 588 250		2500 mm	
VW Crafter	183 188 100		1000 mm	a petición on request
	183 188 160		1600 mm	
	183 188 200		2000 mm	
	183 188 250		2500 mm	
Nissan Alteo Cabstar	183 388 100		1000 mm	a petición on request
	183 388 160		1600 mm	
	183 388 200		2000 mm	
	183 388 250		2500 mm	
Mitsubishi	183 288 100		1000 mm	a petición on request
	183 288 160		1600 mm	
	183 288 200		2000 mm	
	183 288 250		2500 mm	



ALUMBRADO PARTE TRASERA

Taillights

adaptado para (fits for) IVECO, Mercedes Benz, VW, Nissan, Mitsubishi

7 polos prolongadores 90° + luz matrícula - 7-pole extension 90° + plate light



Cable alargador de 7 polos 24 V con una salida para las luces de limitación (58).

Opcional:

- Una salida para las 3. luces de freno (54): (Art.-No. + "B") p.ej.: 083 332 162 B
- Una salida para la luz de matrícula (Art.-No. + "K") p.ej.: 083 322 162 K

Adaptador 90° / 180°. Otras longitudes disponibles a petición.

7-pole extension 24 V with a leaving for a side light (58).

optional:

- For a leaving 3. stop light (54): (art.-no. + "B") e. g. 083 332 162 B
- For a leaving plate light: (art.-no. + "K") e. g. 083 322 162 K

Adapter 90° / 180°. Further lengths on request.

adaptado para fits for	Art. - No. Art. no.	Referencia No. comparison no.	Longitud length	Ejecución execution	Precio price
IVECO Daily	083 332 162		1600 mm	2 x 1,0 mm² cable redondo	a petición on request
	083 332 202		2000 mm	2 x 1,0 mm² round cable	
	083 335 162		1600 mm	2 x 1,5 mm² Aspöck P&R	
	083 335 202		2000 mm	2 x 1,5 mm² Aspöck P&R	
	083 337 162		1600 mm	2 x 0,75 mm² Aspöck DC	
	083 337 202		2000 mm	2 x 0,75 mm² Aspöck DC	
Mercedes Benz	083 532 162		1600 mm	2 x 1,0 mm² cable redondo	a petición on request
	083 532 202		2000 mm	2 x 1,0 mm² round cable	
	083 535 162		1600 mm	2 x 1,5 mm² Aspöck P&R	
	083 535 202		2000 mm	2 x 1,5 mm² Aspöck P&R	
VW Crafter	183 132 162		1600 mm	2 x 1,0 mm² cable redondo	a petición on request
	183 132 202		2000 mm	2 x 1,0 mm² round cable	
	183 135 162		1600 mm	2 x 1,5 mm² Aspöck P&R	
	183 135 202		2000 mm	2 x 1,5 mm² Aspöck P&R	
Nissan Alteo Cabstar	183 332 162		1600 mm	2 x 1,0 mm² cable redondo	a petición on request
	183 332 202		2000 mm	2 x 1,0 mm² round cable	
	183 335 162		1600 mm	2 x 1,5 mm² Aspöck P&R	
	183 335 202		2000 mm	2 x 1,5 mm² Aspöck P&R	
Mitsubishi	183 232 162		1600 mm	2 x 1,0 mm² cable redondo	a petición on request
	183 232 202		2000 mm	2 x 1,0 mm² round cable	
	183 235 162		1600 mm	2 x 1,5 mm² Aspöck P&R	
	183 253 202		2000 mm	2 x 1,5 mm² Aspöck P&R	

7 polos prolongadores 180° + luz matrícula - 7-pole extension 180° + plate light

Cable alargador de 7 polos 24 V con una salida para las luces de limitación (58).

Opcional:

- Una salida para las 3. luces de peno (54): (Art.-No. + "B") p.ej.: 083 332 162 B
- Una salida para la luz de matrícula (Art.-No. + "K") p.ej.: 083 322 162 K























Adaptador 2 x 180°. Otras longitudes disponibles a petición.

7-pole extension 24 V with a leaving for a side light (58).

optional:

- For a leaving 3. stop light (54): (art.-no. + "B") e. g. 083 332 162 B
- For a leaving plate light: (art.-no. + "K") e. g. 083 322 162 K

Adapter 2 x 180°. Further lengths on request.

adaptado para fits for	Art. - No. Art. no.	Referencia No. comparison no.	Longitud length	Ejecución execution	Precio price
IVECO Daily	083 342 162		1600 mm	 2 x 1,0 mm ² cable redondo	a petición on request
	083 342 202		2000 mm	 2 x 1,0 mm ² round cable	
	083 345 162		1600 mm	 2 x 1,5 mm ² Aspöck P&R	
	083 345 202		2000 mm	 2 x 1,5 mm ² Aspöck P&R	
	083 347 162		1600 mm	 2 x 0,75 mm ² Aspöck DC	
	083 347 202		2000 mm	 2 x 0,75 mm ² Aspöck DC	
Mercedes Benz	083 542 162		1600 mm	 2 x 1,0 mm ² cable redondo	a petición on request
	083 542 202		2000 mm	 2 x 1,0 mm ² round cable	
	083 545 162		1600 mm	 2 x 1,5 mm ² Aspöck P&R	
	083 545 202		2000 mm	 2 x 1,5 mm ² Aspöck P&R	
VW Crafter	183 142 162		1600 mm	 2 x 1,0 mm ² cable redondo	a petición on request
	183 142 202		2000 mm	 2 x 1,0 mm ² round cable	
	183 145 162		1600 mm	 2 x 1,5 mm ² Aspöck P&R	
	183 145 202		2000 mm	 2 x 1,5 mm ² Aspöck P&R	
Nissan Alteo Cabstar	183 342 162		1600 mm	 2 x 1,0 mm ² cable redondo	a petición on request
	183 342 202		2000 mm	 2 x 1,0 mm ² round cable	
	183 345 162		1600 mm	 2 x 1,5 mm ² Aspöck P&R	
Mitsubishi	183 345 202		2000 mm	 2 x 1,5 mm ² Aspöck P&R	a petición on request
	183 242 162		1600 mm	 2 x 1,0 mm ² cable redondo	
	183 242 202		2000 mm	 2 x 1,0 mm ² round cable	
	183 245 162		1600 mm	 2 x 1,5 mm ² Aspöck P&R	
			2000 mm	 2 x 1,5 mm ² Aspöck P&R	



ALUMBRADO PARTE TRASERA

Taillights

adaptado para (fits for) Mercedes Benz 2012

7 polos prolongadores 90° - 7-pole extension 90°



Cable alargador de 7 polos 24 V disponible para las luces traseras derecha e izquierda. Adaptador 90° / 180°. Otras longitudes disponibles a petición.

7-pole extension 24 V fits for the left and right taillight. Adapter 90° / 180°. Further lengths on request.

adaptado para fits for	Art. - No. Art. no.	Referencia No. comparison no.	Longitud length	Precio price
MB Actros, MB Antos a partir de 2012	083 005 100		1000 mm	a petición on request
	083 005 160		1600 mm	
	083 005 200		2000 mm	
	083 005 250		2500 mm	
MB Atego a partir de 2013	083 006 100		1000 mm	a petición on request
	083 006 160		1600 mm	
	083 006 200		2000 mm	
	083 006 250		2500 mm	

7 polos prolongadores 180° - 7-pole extension 180°



Cable alargador de 7 polos 24 V disponible para las luces traseras derecha e izquierda. Adaptador 2 x 180°. Otras longitudes disponibles a petición.

7-pole extension 24 V for the left and right taillight. Adapter 2 x 180°. Further lengths on request.

adaptado para fits for	Art. - No. Art. no.	Referencia No. comparison no.	Longitud length	Precio price
MB Actros, MB Antos a partir de 2012	083 885 100		1000 mm	a petición on request
	083 885 160		1600 mm	
	083 885 200	A 960 440 32 53 A9604403253	2000 mm	
	083 885 250		2500 mm	
MB Atego a partir de 2013	083 886 100		1000 mm	a petición on request
	083 886 160		1600 mm	
	038 886 200		2000 mm	
	083 886 250		2500 mm	

7 polos prolongadores 90° + luz matrícula - 7-pole extension 90° + plate light

Cable alargador de 7 polos 24 V con una salida para las luces de limitación (58).

Opcional:

- Una salida para las 3. luces de peno (54): (Art.-No. + "B") p.ej.: 083 332 162 B
- Una salida para la luz de matrícula (Art.-No. + "K") p.ej.: 083 322 162 K

Adaptador 90° / 180°. Otras longitudes disponibles a petición.

7-pole extension 24 V with a leaving for a side light (58).

optional:

- For a leaving 3. stop light (54): (art.-no. + "B") e. g. 083 332 162 B
- For a leaving plate light: (art.-no. + "K") e. g. 083 322 162 K

Adapter 90° / 180°. Further lengths on request.



A petición 2 salidas posible.
On request also available with 2 leavings.

adaptado para fits for	Art. - No. Art. no.	Referencia No. comparison no.	Longitud length	Ejecución execution	Precio price	
MB Actros, MB Antos a partir de 2012	083 325 162		1600 mm		a petición on request	
	083 325 202		2000 mm			2 x 1,0 mm² cable redondo
	083 322 162		1600 mm			a petición on request
	083 322 202		2000 mm			
MB Atego a partir de 2013	083 326 162		1600 mm		a petición on request	
	083 326 202		2000 mm			2 x 1,0 mm² cable redondo
	083 356 162		1600 mm			a petición on request
	083 356 202		2000 mm			

7 polos prolongadores 180° + luz matrícula - 7-pole extension 180° + plate light

Cable alargador de 7 polos 24 V con una salida para las luces de limitación (58).

Opcional:

- Una salida para las 3. luces de peno (54): (Art.-No. + "B") p.ej.: 083 332 162 B
- Una salida para la luz de matrícula (Art.-No. + "K") p.ej.: 083 322 162 K

Adaptador 2 x 180°. Otras longitudes disponibles a petición.

7-pole extension 24 V with a leaving for a side light (58).

optional:

- For a leaving 3. stop light (54): (art.-no. + "B") e. g. 083 332 162 B
- For a leaving plate light: (art.-no. + "K") e. g. 083 322 162 K

Adapter 2 x 180°. Further lengths on request.



A petición 2 salidas posible.
On request also available with 2 leavings.

adaptado para fits for	Art. - No. Art. no.	Referencia No. comparison no.	Longitud length	Ejecución execution	Precio price	
MB Actros a partir de 2012	083 425 162		1600 mm		a petición on request	
	083 425 202		2000 mm			2 x 1,0 mm² cable redondo
	083 422 162		1600 mm			a petición on request
	083 422 202		2000 mm			
MB Atego a partir de 2013	083 435 162		1600 mm		a petición on request	
	083 435 202		2000 mm			2 x 1,0 mm² Rundleitung
	083 432 162		1600 mm			a petición on request
	083 432 202		2000 mm			



ALUMBRADO PARTE TRASERA

Taillights

adaptado para (fits for) DAF 2013

8 polos prolongadores 90° - 8-pole extension 90°



Cable alargador de 8 polos 24 V disponible para las luces traseras derecha e izquierda. Adaptador 90° / 180°. Otras longitudes disponibles a petición.

8-pole extension 24 V fits for the left and right taillight. Adapter 90° / 180°. Further lengths on request.

adaptado para fits for	Art. - No. Art. no.	Referencia No. comparison no.	Longitud length	Precio price
DAF a partir de 2013	183 008 100		1000 mm	a petición on request
	183 008 160		1600 mm	
	183 008 200		2000 mm	
	183 008 250		2500 mm	

8 polos prolongadores 180° - 8-pole extension 180°



Cable alargador de 8 polos 24 V disponible para las luces traseras derecha e izquierda. Adaptador 2 x 180°. Otras longitudes disponibles a petición.

8-pole extension 24 V fits for the left and right taillight. Adapter 2 x 180°. Further lengths on request.

adaptado para fits for	Art. - No. Art. no.	Referencia No. comparison no.	Longitud length	Precio price
DAF a partir de 2013	183 088 100		1000 mm	a petición on request
	183 088 160		1600 mm	
	183 088 200		2000 mm	
	183 088 250		2500 mm	

8 polos prolongadores 90° + luz matrícula - 8-pole extension 90° + plate light



Cable alargador de 8 polos 24 V con una salida para las luces de limitación (58).

Opcional:

- Una salida para las 3. luces de peno (54): (Art.-No. + "B") p.ej.: 083 332 162 B
- Una salida para la luz de matrícula (Art.-No. + "K") p.ej.: 083 322 162 K



Adaptador 90° / 180°. Otras longitudes disponibles a petición.

8-pole extension 24 V with a leaving for a side light (58).

optional:

- For a leaving 3. stop light (54): (art.-no. + "B") e. g. 083 332 162 B
- For a leaving plate light: (art.-no. + "K") e. g. 083 322 162 K

Adapter 90° / 180°. Further lengths on request.

adaptado para fits for	Art. - No. Art. no.	Referencia No. comparison no.	Longitud length	Ejecución execution	Precio price	
DAF a partir de 2013	183 328 162		1600 mm		a petición on request	
	183 328 202		2000 mm			2 x 1,0 mm ² cable redondo 2 x 1,0 mm ² round cable
	183 358 162		1600 mm			2 x 1,5 mm ² Aspöck P&R
	183 358 202		2000 mm			2 x 1,5 mm ² Aspöck P&R

8 polos prolongadores 180° + luz matrícula - 8-pole extension 180° + plate light



Cable alargador de 8 polos 24 V con una salida para las luces de limitación (58).

Opcional:

- Una salida para las 3. luces de peno (54): (Art.-No. + "B") p.ej.: 083 332 162 B
- Una salida para la luz de matrícula (Art.-No. + "K") p.ej.: 083 322 162 K



Adaptador 2 x 180°. Otras longitudes disponibles a petición.

8-pole extension 24 V with a leaving for a side light (58).

optional:

- For a leaving 3. stop light (54): (art.-no. + "B") e. g. 083 332 162 B
- For a leaving plate light: (art.-no. + "K") e. g. 083 322 162 K

Adapter 2 x 180°. Further lengths on request.

adaptado para fits for	Art. - No. Art. no.	Referencia No. comparison no.	Longitud length	Ejecución execution	Precio price	
DAF a partir de 2013	183 428 162		1600 mm		a petición on request	
	183 428 202		2000 mm			2 x 1,0 mm ² cable redondo 2 x 1,0 mm ² round cable
	183 458 162		1600 mm			2 x 1,5 mm ² Aspöck P&R
	183 458 202		2000 mm			2 x 1,5 mm ² Aspöck P&R



ALUMBRADO PARTE TRASERA

Taillights

adaptado para (fits for) MAN, Mercedes Benz, IVECO

8 polos prolongadores 90° - 8-pole extension 90°



Cable alargador de 8 polos 24 V disponible para las luces traseras derecha e izquierda. Adaptador 90° / 180°. Otras longitudes disponibles a petición.

8-pole extension 24 V fits for the left and right taillight. Adapter 90° / 180°. Further lengths on request.

adaptado para fits for	Art. - No. Art. no.	Referencia No. comparison no.	Longitud length	Precio price
MAN 2000	083 200 100	81.25418-6937	81254186937	1000 mm
	083 200 160	81.25418-6938	81254186938	1600 mm
	083 200 200			2000 mm
	083 200 250			2500 mm
MB Atego	083 600 100			1000 mm
	083 600 160			1600 mm
	083 600 200			2000 mm
	083 600 250			2500 mm
a partir de 2013 IVECO Stralis Euro 6 IVECO Eurocargo Euro 6 IVECO Trakker Euro 6	083 004 100			1000 mm
	083 004 160			1600 mm
	083 004 200			2000 mm
	083 004 250			2500 mm

a petición
on request

a petición
on request

a petición
on request

8 polos prolongadores 180° - 8-pole extension 180°



Cable alargador de 8 polos 24 V disponible para las luces traseras derecha e izquierda. Adaptador 2 x 180°. Otras longitudes disponibles a petición.

8-pole extension 24 V fits for the left and right taillight. Adapter 2 x 180°. Further lengths on request.

adaptado para fits for	Art. - No. Art. no.	Referencia No. comparison no.	Longitud length	Precio price
MAN 2000	083 288 100		1000 mm	a petición on request
	083 288 160		1600 mm	
	083 288 200		2000 mm	
	083 288 250		2500 mm	
MB Atego	083 688 100		1000 mm	a petición on request
	083 688 160		1600 mm	
	083 688 200		2000 mm	
	083 688 250		2500 mm	
a partir de 2013 IVECO Stralis Euro 6 IVECO Eurocargo Euro 6 IVECO Trakker Euro 6	083 884 100		1000 mm	a petición on request
	083 884 160		1600 mm	
	083 884 200		2000 mm	
	083 884 250		2500 mm	



ALUMBRADO PARTE TRASERA

Taillights

adaptado para (fits for) MAN, Mercedes Benz, IVECO

8 polos prolongadores 90° + luz matrícula - 8-pole extension 90° + plate light



Cable alargador de 8 polos 24 V con una salida para las luces de limitación (58).

Opcional:

- Una salida para las 3. luces de peno (54): (Art.-No. + "B") p.ej.: 083 332 162 B
- Una salida para la luz de matrícula (Art.-No. + "K") p.ej.: 083 322 162 K

Adaptador 90° / 180°. Otras longitudes disponibles a petición.

8-pole extension 24 V with a leaving for a side light (58).

optional:

- For a leaving 3. stop light (54): (art.-no. + "B") e. g. 083 332 162 B
- For a leaving plate light: (art.-no. + "K") e. g. 083 322 162 K

Adapter 90° / 180°. Further lengths on request.

adaptado para fits for	Art. - No. Art. no.	Referencia No. comparison no.	Longitud length	Ejecución execution	Precio price
MAN 2000	083 232 162		1600 mm	2 x 1,0 mm ² cable redondo 2 x 1,0 mm ² round cable	a petición on request
	083 232 202		2000 mm		
	083 235 162		1600 mm	2 x 1,5 mm ² Aspöck P&R 2 x 1,5 mm ² Aspöck P&R	
	083 235 202		2000 mm		
MB Atego	083 632 162		1600 mm	2 x 1,0 mm ² cable redondo 2 x 1,0 mm ² round cable	a petición on request
	083 632 202		2000 mm		
	083 635 162		1600 mm	2 x 1,5 mm ² Aspöck P&R 2 x 1,5 mm ² Aspöck P&R	
	083 635 202		2000 mm		
a partir de 2013 IVECO Stralis Euro 6 IVECO Trakker Euro 6 IVECO Eurocargo Euro 6	083 324 162		1600 mm	2 x 1,0 mm ² cable redondo 2 x 1,0 mm ² round cable	a petición on request
	083 324 202		2000 mm		
	083 354 162		1600 mm	2 x 1,5 mm ² Aspöck P&R 2 x 1,5 mm ² Aspöck P&R	
	083 354 202		2000 mm		

8 polos prolongadores 180° + luz matrícula - 8-pole extension 180° + plate light

Cable alargador de 8 polos 24 V con una salida para las luces de limitación (58).

Opcional:

- Una salida para las 3. luces de peno (54): (Art.-No. + "B") p.ej.: 083 332 162 B
- Una salida para la luz de matrícula (Art.-No. + "K") p.ej.: 083 322 162 K



Adaptador 2 x 180°. Otras longitudes disponibles a petición.

8-pole extension 24 V with a leaving for a side light (58).

optional:

- For a leaving 3. stop light (54): (art.-no. + "B") e. g. 083 332 162 B
- For a leaving plate light: (art.-no. + "K") e. g. 083 322 162 K

Adapter 2 x 180°. Further lengths on request.

adaptado para fits for	Art. - No. Art. no.	Referencia No. comparison no.	Longitud length	Ejecución execution	Precio price
MAN 2000	083 242 162		1600 mm		a petición on request
	083 242 202		2000 mm		
	083 245 162		1600 mm		
	083 245 202		2000 mm		
MB Atego	083 642 162		1600 mm		a petición on request
	083 642 202		2000 mm		
	083 645 162		1600 mm		
	083 645 202		2000 mm		
a partir de 2013 IVECO Stralis Euro 6 IVECO Trakker Euro 6 IVECO Eurocargo Euro 6	083 424 162		1600 mm		a petición on request
	083 424 202		2000 mm		
	083 454 162		1600 mm		
	083 454 202		2000 mm		



ALUMBRADO PARTE TRASERA

Taillights

adaptado para (fits for) DAF, IVECO, MAN, Ford

8 polos prolongadores 90° - 8-pole extension 90°



Cable alargador de 8 polos 24 V disponible para las luces traseras derecha e izquierda. Adaptador 90° / 180°. Otros longitudes disponibles a petición.

8-pole extension 24 V fits for the left and right taillight. Adapter 90° / 180°. Further lengths on request.

adaptado para fits for	Art. - No. Art. no.	Referencia No. comparison no.	Longitud length	Precio price
DAF XF	183 800 100		1000 mm	a petición on request
	183 800 160		1600 mm	
	183 800 200		2000 mm	
	183 800 250		2500 mm	

8 polos prolongadores 180° - 8-pole extension 180°



Cable alargador de 8 polos 24 V disponible para las luces traseras derecha e izquierda. Adaptador 2 x 180°. Otros longitudes disponibles a petición.

8-pole extension 24 V fits for the left and the right taillight. Adapter 2 x 180°. Further lengths on request.

adaptado para fits for	Art. - No. Art. no.	Referencia No. comparison no.	Longitud length	Precio price
DAF XF	183 888 100		1000 mm	a petición on request
	183 888 160		1600 mm	
	183 888 200		2000 mm	
	183 888 250		2500 mm	

10 polos (8 polos) prolongadores 90° - 10-pole (8-pole) extension 90°



Cable alargador de 10 polos (8-polos) 24 V para las luces traseras derecha e izquierda. Se incluye un enchufe de 8 polos, contactos y juntas. Adaptador 90° / 180°. Otras longitudes disponibles a petición.

10-pole (8-pole) extension 24 V fits for the left and right taillight. Including 8-pole socket housing, contactors and seals. Further lengths on request.

adaptado para fits for	Art. - No. Art. no.	Referencia No. comparison no.	Longitud length	Precio price
IVECO Stralis, Trakker	083 400 100		1000 mm	a petición on request
	083 400 160		1600 mm	
	083 400 200		2000 mm	
	083 400 250		2500 mm	

Prolongadores en Y 180° - Y-extension 180°



Cable alargador de 7 polos en forma Y de 24 V para conectar 2 lámparas traseras.
Otras longitudes disponibles a petición.

7-pole Y-extension 24 V for connection of a 2. taillight.
Further lengths on request.

adaptado para fits for	Art. - No. Art. no.	Referencia No. comparison no.	A en mm A in mm	B en mm B in mm	C en mm C in mm	Precio price
MANTG	483 025 110	81.25432-6164 81254326164	250	250	1100	a petición on request
	483 025 160	81.25432-6165 81254326165	250	250	1600	
	483 025 200		250	250	2000	
	483 025 300		250	250	3000	

8 polos prolongadores 180° - 8-pole extension 180°

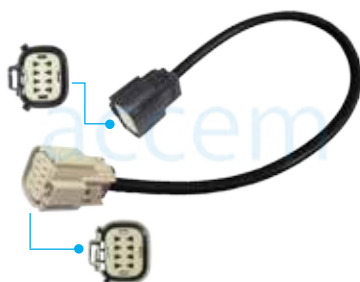

Cable alargador de 8 polos 24 V disponible para las luces traseras derecha e izquierda.
Adaptador 2 x 180°. Otras longitudes disponibles a petición.

8-pole extension 24 V fits for the left and the right taillight. Adapter 2 x 180°.
Further lengths on request.

adaptado para fits for	Art. - No. Art. no.	Referencia No. comparison no.	Longitud length	Precio price
Ford	183 788 100		1000 mm	a petición on request
	183 788 160		1600 mm	
	183 788 200		2000 mm	

8 polos prolongadores 180° + luz matrícula - 8-pole extension 180° + plate light



Cable alargador de 8 polos 24 V con una salida para las luces de limitación (58).
Opcional:

- Una salida para las 3. luces de peno (54): (Art.-No. + "B") p.ej.: 083 322 162 B
- Una salida para la luz de matrícula (Art.-No. + "K") p.ej.: 083 322 162 K

Otras longitudes disponibles a petición.

8-pole extension 24 V with a leaving for a side light (58).

optional:

- For a leaving 3. stop light (54): (art.-no. + "B") e. g. 083 322 162 B
- For a leaving plate light: (art.-no. + "K") e. g. 083 322 162 K

Further lengths on request.

adaptado para fits for	Art. - No. Art. no.	Referencia - No. comparison no.	Longitud length	Ejecución execution	Precio price
Ford Transit	183 742 162		1600 mm	 2 x 1,0 mm ² cable redondo	a petición on request
	183 742 202		2000 mm	 2 x 1,0 mm ² round cable	
	183 745 162		1600 mm	 2 x 1,5 mm ² Aspöck P&R	
	183 745 202		2000 mm	 2 x 1,5 mm ² Aspöck P&R	
	183 747 162		1600 mm	 2 x 1,5 mm ² Aspöck DC	
	183 747 202		2000 mm	 2 x 1,5 mm ² Aspöck DC	



ALUMBRADO PARTE TRASERA

Taillights

Cable adaptador Adaptercables

7 polos Cable adaptador 180° - 7-pole adapter cable 180°

Cable adaptador de 7 polos para el piloto trasero. Otras longitudes disponibles a petición.

7-pole adapter cable for the taillight. Further lengths on request.



adaptado para fits for	Art. - No. Art. no.	Adaptador adapter	Longitud length	Precio price
de MAN TG a MB nuevo	083 043 100	90° / 180°	1000 mm	a petición on request
	083 043 160	90° / 180°	1600 mm	
	083 043 200	90° / 180°	2000 mm	
	083 043 250	90° / 180°	2500 mm	
de MAN TG a MB nuevo	083 843 100	2 x 180°	1000 mm	a petición on request
	083 843 160	2 x 180°	1600 mm	
	083 843 200	2 x 180°	2000 mm	
	083 843 250	2 x 180°	2500 mm	

7 polos Cable adaptador 90° - 7-pole adapter cable 90°

Cable adaptador de 7 polos con 2 cajas de enchufes para el piloto trasero. Otras longitudes disponibles a petición.

7-pole adapter cable (with 2 socket housings) for the taillight. Further lengths on request.



adaptado para fits for	Art. - No. Art. no.	Adaptador adapter	Longitud length	Precio price
de MAN TG a MB nuevo	083 041 100	90° / 180°	1000 mm	a petición on request
	083 041 160	90° / 180°	1600 mm	
	083 041 200	90° / 180°	2000 mm	
	083 041 250	90° / 180°	2500 mm	
	083 041 001	90° / 180°	10000 mm	
de MAN TG a MB nuevo	083 841 100	2 x 180°	1000 mm	a petición on request
	083 841 160	2 x 180°	1600 mm	
	083 841 200	2 x 180°	2000 mm	
	083 841 250	2 x 180°	2500 mm	
	083 841 001	2 x 180°	10000 mm	

8 polos cable adaptador - 8-pole adapter cable

Cable adaptador de 8 polos (con 2 cajas de enchufes) para lámpara trasera. Conexión de luz 90°. Otras longitudes disponibles a petición.

8-pole adapter cable (with 2 socket housing) for the taillight. Light connection 90°. Further lengths on request.

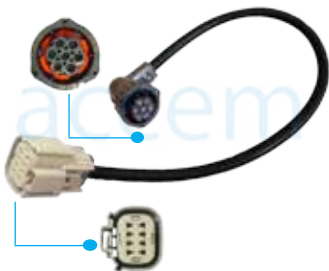

adaptado para fits for	Art. - No. Art. no.	Referencia No. comparison no.	Longitud length	Precio price
de Ford Transit a IVECO Daily izquierda	183 047 100 L		1000 mm	a petición on request
	183 047 160 L		1600 mm	
	183 047 200 L		2000 mm	
de Ford Transit a IVECO Daily derecha	183 047 100 R		1000 mm	a petición on request
	183 047 160 R		1600 mm	
	183 047 200 R		2000 mm	

7 polos Cable de conexión - 7-pole connecting cable

Interconector de 7 polor con 2 cajas de enchufes para el piloto trasero. Otras longitudes disponibles a petición.

7-pole connecting cable (with 2 socket housings) for the taillight. Further lengths on request.





Art. - No. Art. no.	Adaptador adapter	Longitud length	Precio price
083 140 100	90° / 180°	1000 mm	a petición on request
083 140 160	90° / 180°	1600 mm	
083 140 200	90° / 180°	2000 mm	
083 140 250	90° / 180°	2500 mm	a petición on request
083 148 100	2 x 180°	1000 mm	
083 148 160	2 x 180°	1600 mm	
083 148 200	2 x 180°	2000 mm	
083 148 250	2 x 180°	2500 mm	

Caja de conexión de cables - cable connection box

Caja de conexión de cables con 4x7 polos. Bayoneta de conectores y 4 cables de conexión.

Cable connection box with 4 x 7-pole Bajonett-plug socket and 4 connection cables.



Art. - No. Art. no.	Longitud length	Ejecución execution	Precio price
020 472 422	2000 mm		4 pieza 2 x 1,0 mm ² cable ronde 4 piece 2 x 1,0 mm ² round cable
020 472 424	4000 mm		
020 475 422	2000 mm		4 pieza 2 x 1,5 mm ² Aspöck P&R 4 piece 2 x 1,5 mm ² Aspöck P&R
020 475 424	4000 mm		
020 474 422	2000 mm		4 pieza 2 x 1,0 mm ² cable ronde ADR 4 piece 2 x 1,0 mm ² round cable ADR
020 474 424	4000 mm		

Alumbrado lateral

Prolongadores

Este grupo de productos incluye prolongadores, cables de conexión y prolongadores en Y.
Nosotros podemos realizar variaciones específicas a petición.

SIDE-MARKER LAMPS - EXTENSIONS

This product line includes extensions, connecting cables and Y-extensions.
We generate and manufacture custom-specific variations.

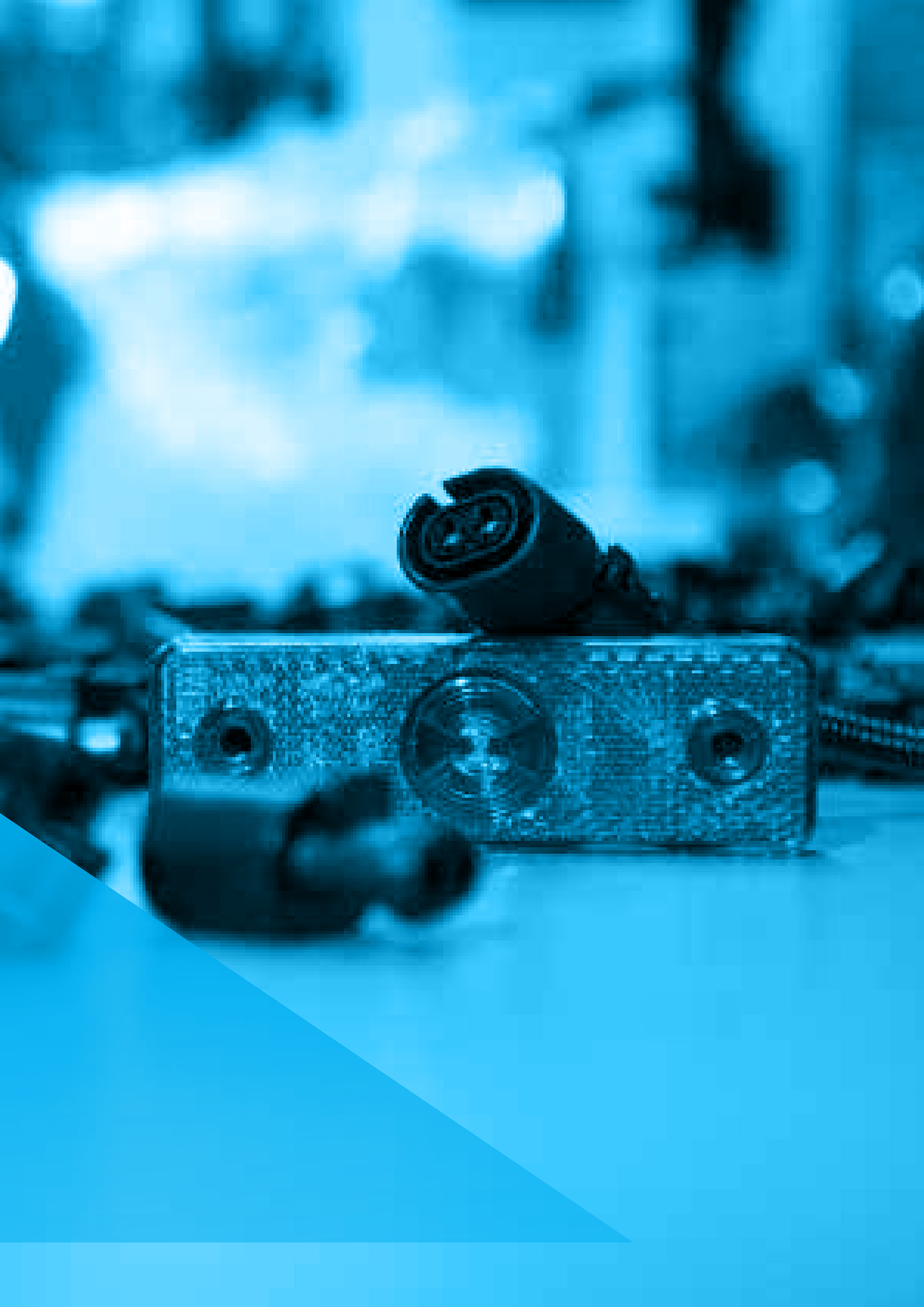



ALUMBRADO LATERAL

Side-marker lamps

adaptado para (fits for) MAN

2 polos prolongadores - 2-pole extension



**Alargador de 2 polos para las luces de posición laterales.
Otras longitudes disponibles a petición.**

2-pole extension for the side-marker lamp.
Further lengths on request.

adaptado para fits for	Art. - No. Art. no.	Referencia No. comparison no.	Longitud length	Ejecución execution	Precio price	
MAN	084 144 002	81.25429-6294	81254296294	2000 mm	2 x 1,0 mm ² tubo ondulado 2 x 1,0 mm ² corrugated tube	a petición on request
	084 144 004	81.25429-6295	81254296295	4000 mm		
	084 142 002			2000 mm	2 x 1,0 mm ² cable redondo 2 x 1,0 mm ² round cable	
	084 142 004			4000 mm		

Distribuidor en T - T-distributor



Distributore de 2 polos en forma T (con 3 caja de lápiz).

2-pole T-distributor (with 3 pin housings).

adaptado para fits for	Art. - No. Art. no.	Referencia No. comparison no.	Precio price
MAN	114 020 333		a petición on request

2 polos cable de conexión - 2-pole connecting cable



**Cable conector de 2 polos (con 2 caja de lápiz) para las luces de posición lateral.
Otras longitudes disponibles a petición.**

2-pole connecting cable (with 2 socket housings) for the side-marker lamp.
Further lengths on request.



adaptado para fits for	Art. - No. Art. no.	Referencia No. comparison no.	Longitud length	Ejecución execution	Precio price
MAN	084 164 105		150 mm	2 x 1,0 mm ² tubo ondulado 2 x 1,0 mm ² corrugated tube	a petición on request
	084 164 002		2000 mm		
	084 164 004	81.25427-6757	81254276757		
	084 162 002		2000 mm	2 x 1,0 mm ² cable redondo 2 x 1,0 mm ² round cable	
	084 162 004		4000 mm		

2 polos cable de alimentación - 2-pole connecting cable



Cable de alimentación de 2 polos para las luces de posición laterales con una caja de lápiz.
Otras longitudes disponibles a petición.



2-pole connecting cable for the side-marker lamp with a pin housing.
 Further lengths on request.

adaptado para fits for	Art. - No. Art. no.	Referencia No. comparison no.	Longitud length	Ejecución execution	Precio price
MAN	084 122 002		2000 mm		a petición on request
	084 122 004		4000 mm		
	084 125 002		2000 mm		
	084 125 004		4000 mm		



Cable de alimentación de 2 polos para 2 luces de posición laterales con una caja de lápiz.
Otras longitudes disponibles a petición.

2-pole connecting cable for 2 side-marker lamps with a pin housing.
 Further lengths on request.



adaptado para fits for	Art. - No. Art. no.	Referencia No. comparison no.	Longitud length	Ejecución execution	Precio price
MAN	084 122 202		2000 mm		a petición on request
	084 122 204		4000 mm		
	084 125 202		2000 mm		
	084 125 204		4000 mm		

2 polos cable de alimentación - 2-pole connecting cable



Cables de alimentación de 2 polos para las luces de posición laterales con una caja de hembrillas.
Otras longitudes disponibles a petición.



2-pole connecting cable for the side-marker lamp with a socket housing.
 Further lengths on request.

adaptado para fits for	Art. - No. Art. no.	Referencia No. comparison no.	Longitud length	Ejecución execution	Precio price
MAN	084 122 102		2000 mm		a petición on request
	084 122 104		4000 mm		
	084 125 102		2000 mm		
	084 125 104		4000 mm		



Cables de alimentación de 2 polos para 2 luces de posición laterales con una caja de hembrillas.
Otras longitudes disponibles a petición.

2-pole connecting cable for 2 side-marker lamps with a socket housing.
 Further lengths on request.

adaptado para fits for	Art. - No. Art. no.	Referencia No. comparison no.	Longitud length	Ejecución execution	Precio price
MAN	084 122 302		2000 mm		a petición on request
	084 122 304		4000 mm		
	084 125 302		2000 mm		
	084 125 304		4000 mm		



ALUMBRADO LATERAL

Side-marker lamps

adaptado para (fits for) Mercedes Benz, Scania

2 polos prolongadores - 2-pole extension



Alargador de 2 polos para las luces de posición laterales. Otras longitudes disponibles a petición.

2-pole extension for the side-marker lamp. Further lengths on request.

adaptado para fits for	Art. - No. Art. no.	Referencia No. comparison no.	Longitud length	Ejecución execution	Precio price
MB Actros Scania Volvo	084 544 002		2000 mm	2 x 1,0 mm ² tubo ondulado	a petición on request
	084 544 004		4000 mm	2 x 1,0 mm ² corrugated tube	
	084 542 002		2000 mm	2 x 1,0 mm ² cable redondo	
	084 542 004		4000 mm	2 x 1,0 mm ² round cable	

Prolongadores en Y - Y-extension



Cable alargador de 2 polos en forma Y para 2 luces de posición laterales. Otras longitudes disponibles a petición.

2-pole Y-extension for 2 side-marker lamps. Further lengths on request.

adaptado para fits for	Art. - No. Art. no.	Referencia No. comparison no.	A en mm A in mm	B en mm B in mm	C en mm C in mm	Precio price
MB Actros Scania Volvo	084 588 201		800	1800	200	a petición on request
	084 588 202		1800	1800	200	
	084 588 203		1800	2800	200	
	084 588 204		1800	3800	200	

Cable de alimentación en Y - Y-connecting cable



Cable de corexión de 2 polos en forma de Y con cable alargador de las luces de posición laterales y con una corexión adicional a otras 2 luces posición laterales. Otras longitudes disponibles a petición.

2-pole Y-connecting cable for the extension of the side-marker lamp and for additional connection of a 2. side-marker lamp. Further lengths on request.



adaptado para fits for	Art. - No. Art. no.	Referencia No. comparison no.	A en mm	B en mm	C en mm	Ejecución execution	Precio price
MB Actros Scania Volvo	284 502 023		250	250	3000	2 x 1,0 mm ² cable redondo	a petición on request
	284 505 055		500	500	5000	2 x 1,0 mm ² round cable	
	384 502 023		250	250	3000	2 x 1,5 mm ² Aspöck P&R	
	384 505 055		500	500	5000	2 x 1,5 mm ² Aspöck P&R	

2 polos cable de alimentación - 2-pole connecting cable



Cable de alimentación de 2 polos para las luces de posición laterales con una caja de lápiz. Otras longitudes disponibles a petición.



2-pole connecting cable for the side-marker lamp with a pin housing. Further lengths on request.

adaptado para fits for	Art. - No. Art. no.	Referencia No. comparison no.	Longitud length	Ejecución execution	Precio price
MB Actros Scania Volvo	084 522 002		2000 mm	 2 x 1,0 mm ² cable redondo 2 x 1,0 mm ² round cable	a petición on request
	084 522 004		4000 mm		
	084 525 002		2000 mm	 2 x 1,5 mm ² Aspöck P&R 2 x 1,5 mm ² Aspöck P&R	
	084 525 004		4000 mm		

Cable de alimentación de 2 polos para 2 luces de posición laterales con una caja de lápiz. Otras longitudes disponibles a petición.

2-pole connecting cable for 2 side-marker lamps with a pin housing. Further lengths on request.





adaptado para fits for	Art. - No. Art. no.	Referencia No. comapison no.	Longitud length	Ejecución execution	Precio price
MB Actros Scania Volvo	084 522 202		2000 mm	 2 x 1,0 mm ² cable redondo 2 x 1,0 mm ² round cable	a petición on request
	084 522 204		4000 mm		
	084 525 202		2000 mm	 2 x 1,5 mm ² Aspöck P&R 2 x 1,5 mm ² Aspöck P&R	
	084 525 204		4000 mm		

2 polos cable de alimentación - 2-pole connecting cable



Cables de alimentación de 2 polos para las luces de posición laterales con una caja de hembrillas. Otras longitudes disponibles a petición.



2-pole connecting cable for the side-marker lamp with a socket housing. Further lengths on request.

adaptado para fits for	Art. - No. Art. no.	Referencia No. comparison no.	Longitud length	Ejecución execution	Precio price
MB Actros Scania Volvo	084 522 102		2000 mm	 2 x 1,0 mm ² cable redondo 2 x 1,0 mm ² round cable	a petición on request
	084 522 104		4000 mm		
	084 525 102		2000 mm	 2 x 1,5 mm ² Aspöck P&R 2 x 1,5 mm ² Aspöck P&R	
	084 525 104		4000 mm		

Cables de alimentación de 2 polos para 2 luces de posición laterales con una caja de hembrillas. Otras longitudes disponibles a petición.

2-pole connecting cable for 2 side-marker lamps with a socket housing. Further lengths on request.



adaptado para fits for	Art. - No. Art. no.	Referencia No. comparison no.	Longitud length	Ejecución execution	Precio price
MB Actros Scania Volvo	084 522 302		2000 mm	 2 x 1,0 mm ² cable redondo 2 x 1,0 mm ² round cable	a petición on request
	084 522 304		4000 mm		
	084 525 302		2000 mm	 2 x 1,5 mm ² Aspöck P&R 2 x 1,5 mm ² Aspöck P&R	
	084 525 304		4000 mm		



ALUMBRADO LATERAL

Side-marker lamps





adaptado para (fits for) div. Vignal

2 polos prolongadores - 2-pole extension



2 polos prolongador para las lámparas de señalización laterales.
Otras longitudes disponibles a petición.

2-pole extension for the side-marker lamp.
Further lengths on request.

adaptado para fits for	Art. - No. Art. no.	Referencia No. comparison no.	Longitud length	Ejecución execution	Precio price
div. Vignal	084 044 012	5010513874	2000 mm	 2 x 1,0 mm ² tubo ondulado	a petición on request
	084 044 014		4000 mm	 2 x 1,0 mm ² corrugated tube	
	084 042 012		2000 mm	 2 x 1,0 mm ² cable redondo	
	084 042 014		4000 mm	 2 x 1,0 mm ² round cable	

Prolongadores en Y - Y-extension



Cable alargador de 2 polos en forma Y para 2 luces de posición laterales.
Otras longitudes disponibles a petición.

2-pole Y-extension for 2 side-marker lamps.
Further lengths on request.





adaptado para fits for	Art. - No. Art. no.	Referencia No. comparison no.	A en mm A in mm	B en mm B in mm	C en mm C in mm	Precio price
div. Vignal	084 088 201		800	1800	200	a petición on request
	084 088 202		1800	1800	200	
	084 088 203		1800	2800	200	
	084 088 204		1800	3800	200	

Cable de alimentación en Y - Y-connecting cable



Cable de corexión de 2 polos en forma de Y con cable alargador de las luces de posición laterales y con una corexión adicional a otras 2 luces posición laterales. Otras longitudes disponibles a petición.

2-pole Y-connecting cable for the extension of the side-marker lamp and for additional connection of a 2. side-marker lamp. Further lengths on request.



adaptado para fits for	Art. - No. Art. no.	Referencia No. comparison no.	A en mm	B en mm	C en mm	Ejecución execution	Precio price
div. Vignal	284 002 023		250	250	3000	 2 x 1,0 mm ² cable redondo	a petición on request
	284 005 055		500	500	5000	 2 x 1,0 mm ² round cable	
	384 002 023		250	250	3000	 2 x 1,5 mm ² Aspöck P&R	
	384 005 055		500	500	5000	 2 x 1,5 mm ² Aspöck P&R	

2 polos cable de alimentación - 2-pole connecting cable



Cable de alimentación de 2 polos para las luces de posición laterales con una caja de lapíz. Otras longitudes disponibles a petición.



2-pole connecting cable for the side-marker lamp with a pin housing.
Further lengths on request.

adaptado para fits for	Art. - No. Art. no.	Referencia No. comparison no.	Longitud length	Ejecución execution	Precio price
div. Vignal	084 022 012		2000 mm		a petición on request
	084 022 014		4000 mm		
	084 025 012		2000 mm		on request
	084 025 014		4000 mm		



Cable de alimentación de 2 polos para 2 luces de posición laterales con una caja de lapíz. Otras longitudes disponibles a petición.

2-pole connecting cable for 2 side-marker lamps with a pin housing.
Further lengths on request.



adaptado para fits for	Art. - No. Art. no.	Referencia No. comparison no.	Longitud length	Ejecución execution	Precio price
div. Vignal	084 022 212		2000 mm		a petición on request
	084 022 214		4000 mm		
	084 025 212		2000 mm		on request
	084 025 214		4000 mm		

2 polos cable de alimentación - 2-pole connecting cable



Cables de alimentación de 2 polos para las luces de posición laterales con una caja de hembrillas. Otras longitudes disponibles a petición.



2-pole connecting cable for the side-marker lamp with a socket housing.
Further lengths on request.

adaptado para fits for	Art. - No. Art. no.	Referencia No. comparison no.	Longitud length	Ejecución execution	Precio price
div. Vignal	084 022 112		2000 mm		a petición on request
	084 022 114		4000 mm		
	084 025 112		2000 mm		on request
	084 025 114		4000 mm		



Cables de alimentación de 2 polos para 2 luces de posición laterales con una caja de hembrillas. Otras longitudes disponibles a petición.

2-pole connecting cable for 2 side-marker lamps with a socket housing.
Further lengths on request.

adaptado para fits for	Art. - No. Art. no.	Referencia No. comparison no.	Longitud length	Ejecución execution	Precio price
div. Vignal	084 022 312		2000 mm		a petición on request
	084 022 314		4000 mm		
	084 025 312		2000 mm		on request
	084 025 314		4000 mm		



ALUMBRADO LATERAL

Side-marker lamps

2 polos Superseal 2-pole Superseal

2 polos prolongadores - 2-pole extension

2 polos prolongador para las lámparas de señalización laterales.
Otras longitudes disponibles a petición.

2-pole extension for the side-marker lamp.
Further lengths on request.



adaptado para fits for	Art. - No. Art. no.	Referencia No. comparison no.	Longitud length	Ejecución execution	Precio price
div. Proplast	084 844 032		2000 mm	2 x 1,0 mm ² tubo ondulado 2 x 1,0 mm ² corrugated tube	a petición on request
	084 844 034		4000 mm		
	084 842 032		2000 mm	2 x 1,0 mm ² cable redondo 2 x 1,0 mm ² round cable	
	084 842 034		4000 mm		

Prolongadores en Y - Y-extension

Cable alargador de 2 polos en forma Y para 2 luces de posición laterales.
Otras longitudes disponibles a petición.

2-pole Y-extension for 2 side-marker lamps.
Further lengths on request.

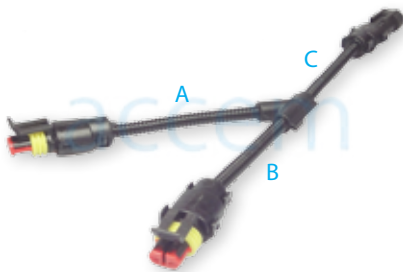

adaptado para fits for	Art. - No. Art. no.	Referencia No. comparison no.	A en mm A in mm	B en mm B in mm	C en mm C in mm	Precio price
div. Proplast	084 888 201		800	1800	200	a petición on request
	084 888 202		1800	1800	200	
	084 888 203		1800	2800	200	
	084 888 204		1800	3800	200	

Cable de alimentación en Y - Y-connecting cable

Cable de corexión de 2 polos en forma de Y con cable alargador de las luces de posición laterales y con una corexión adicional a otras 2 luces posición laterales. Otras longitudes disponibles a petición.

2-pole Y-connecting cable for the extension of the side-marker lamp and for additional connection of a 2. side-marker lamp. Further lengths on request.

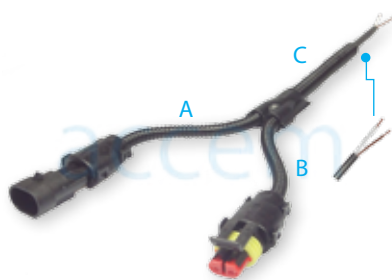



adaptado para fits for	Art. - No. Art. no.	Referencia No. comparison no.	A en mm A in mm	B en mm B in mm	C en mm C in mm	Ejecución execution	Precio price
div. Proplast	284 802 023		250	250	3000	2 x 1,0 mm ² cable redondo 2 x 1,0 mm ² round cable	a petición on request
	284 805 055		500	500	5000		
	384 802 023		250	250	3000	2 x 1,5 mm ² Aspöck P&R 2 x 1,5 mm ² Aspöck P&R	
	384 805 055		500	500	5000		

2 polos cable de alimentación - 2-pole connecting cable



Cable de alimentación de 2 polos (con 2 caja de hembrillas) para las lámparas de señalización laterales. Otras longitudes disponibles a petición.

2-pole connecting cable (with 2 socket housings) for the side-marker lamp. Further lengths on request.



adaptado para fits for	Art. - No. Art. no.	Referencia No. comparison no.	Longitud length	Ejecución execution	Precio price
div. Proplast	084 044 032		2000 mm	 2 x 1,0 mm ² tubo ondulado	a petición
	084 044 034		4000 mm	2 x 1,0 mm ² corrugated tube	
	084 042 032		2000 mm	 2 x 1,0 mm ² cable redondo	on request
	084 042 034		4000 mm	2 x 1,0 mm ² round cable	

2 polos cable de alimentación - 2-pole connecting cable



Cable de alimentación de 2 polos para las lámparas de señalización laterales con una caja de hembrillas e una cara de lápiz. Otras longitudes disponibles a petición.

2-pole connecting cable for side-marker lamps with a pin housing or socket housing. Further lengths on request.





adaptado para fits for	Art. - No. Art. no.	Referencia No. comparison no.	Longitud length	Ejecución execution	Precio price
div. Proplast	084 022 132		2000 mm	 2 x 1,0 mm ² cable redondo	a petición
	084 022 134		4000 mm	2 x 1,0 mm ² round cable	
	084 025 132		2000 mm	 2 x 1,5 mm ² Aspöck P&R	on request
	084 025 134		4000 mm	2 x 1,5 mm ² Aspöck P&R	





adaptado para fits for	Art. - No. Art. no.	Referencia No. comparison no.	Longitud length	Ejecución execution	Precio price
div. Proplast	084 022 232		2000 mm	 2 x 1,0 mm ² cable redondo	a petición
	084 022 234		4000 mm	2 x 1,0 mm ² round cable	
	084 025 232		2000 mm	 2 x 1,5 mm ² Aspöck P&R	on request
	084 025 234		4000 mm	2 x 1,5 mm ² Aspöck P&R	



adaptado para fits for	Art. - No. Art. no.	Referencia No. comparison no.	Longitud length	Ejecución execution	Precio price
div. Proplast	084 022 032		2000 mm	 2 x 1,0 mm ² cable redondo	a petición
	084 022 034		4000 mm	2 x 1,0 mm ² round cable	
	084 025 032		2000 mm	 2 x 1,5 mm ² Aspöck P&R	on request
	084 025 034		4000 mm	2 x 1,5 mm ² Aspöck P&R	



adaptado para fits for	Art. - No. Art. no.	Referencia No. comparison no.	Longitud length	Ejecución execution	Precio price
div. Proplast	084 022 332		2000 mm	 2 x 1,0 mm ² cable redondo	a petición
	084 022 334		4000 mm	2 x 1,0 mm ² round cable	
	084 025 332		2000 mm	 2 x 1,5 mm ² Aspöck P&R	on request
	084 025 334		4000 mm	2 x 1,5 mm ² Aspöck P&R	



ALUMBRADO LATERAL

Side-marker lamps

3 polos Superseal 3-pole Superseal

3 polos prolongadores - 3-pole extension



3 polos prolongador para las lámparas de señalización laterales. Otras longitudes disponibles a petición.

3-pole extension for the side-marker lamp
Further lengths on request.

adaptado para fits for	Art. - No. Art. no.	Referencia No. comparison no.	Longitud length	Ejecución execution	Precio price
IVECO Daily	084 344 002		2000 mm	2 x 1,0 mm ² tubo ondulado 2 x 1,0 mm ² corrugated tube	a petición on request
	084 344 004		4000 mm		
	084 342 002		2000 mm	2 x 1,0 mm ² cable redondo 2 x 1,0 mm ² round cable	
	084 342 004		4000 mm		

Prolongadores en Y - Y-extension



Cable alargador de 3 polos en forma Y para 2 luces de posición laterales. Otras longitudes disponibles a petición.

3-pole Y-extension for 2 side-marker lamps.
Further lengths on request.

adaptado para fits for	Art. - No. Art. no.	Referencia No. comparison no.	A en mm A in mm	B en mm B in mm	C en mm C in mm	Precio price
IVECO Daily	084 388 201		800	1800	200	a petición on request
	084 388 202		1800	1800	200	
	084 388 203		1800	2800	200	
	084 388 204		1800	3800	200	

Cable de alimentación en Y - Y-connecting cable

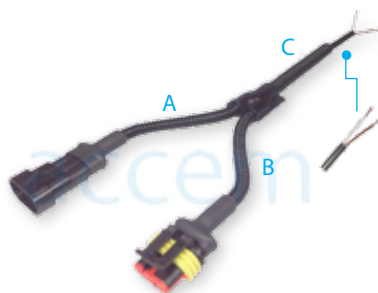

Cable de corexión de 3 polos en forma de Y con cable alargador de las luces de posición laterales y con una corexión adicional a otras 2 luces posición laterales. Otras longitudes disponibles a petición.

3-pole Y-connecting cable for the extension of the side-marker lamp and for additional connection fo a 2. side-marker lamp. Further lengths on request.



adaptado para fits for	Art. - No. Art. no.	Referencia No. comparison no.	A en mm	B en mm	C en mm	Ejecución execution	Precio price
IVECO Daily	284 302 023	250	250	3000	2 x 1,0 mm ² cable redondo 2 x 1,0 mm ² round cable	a petición on request	
	284 305 055	500	500	5000			
	384 302 023	250	250	3000	2 x 1,5 mm ² Aspöck P&R 2 x 1,5 mm ² Aspöck P&R		
	384 305 055	500	500	5000			

3 polos cable de alimentación - 3-pole connecting cable



Cable de alimentación de 3 polos para las luces de posición laterales con una caja de lapiz. Otras longitudes disponibles a petición.



3-pole connecting cable for the side-marker lamp with a pin housing. Further lengths on request.

adaptado para fits for	Art. - No. Art. no.	Referencia No. comparison no.	Longitud length	Ejecución execution	Precio price
IVECO Daily	084 302 002		2000 mm		a petición on request
	084 302 004		4000 mm		
	084 305 002		2000 mm		on request
	084 305 004		4000 mm		

Cable de alimentación de 3 polos para 2 luces de posición laterales con una caja de lapiz. Otras longitudes disponibles por encargo.

3-pole connecting cable for the left and the right side-marker lamp with a pin housing. Further lengths on request.





adaptado para fits for	Art. - No. Art. no.	Referencia No. comparison no.	Longitud length	Ejecución execution	Precio price
IVECO Daily	084 302 202		2000 mm		a petición on request
	084 302 204		4000 mm		
	084 305 202		2000 mm		on request
	084 305 204		4000 mm		

3 polos cable de alimentación - 3-pole connecting cable



Cables de alimentación de 3 polos para las luces de posición laterales con una caja de hembrillas. Otras longitudes disponibles a petición.



3-pole connecting cable for the side-marker lamp with a socket housing. Further lengths on request.

adaptado para fits for	Art. - No. Art. no.	Referencia No. comparison no.	Longitud length	Ejecución execution	Precio price
IVECO Daily	084 302 102		2000 mm		a petición on request
	084 302 104		4000 mm		
	084 305 102		2000 mm		on request
	084 305 104		4000 mm		

Cables de alimentación de 3 polos para 2 luces de posición laterales con una caja de hembrillas. Otras longitudes disponibles a petición.

3-pole connecting cable for the left and the right side-marker lamp with a socket housing. Further lengths on request.



adaptado para fits for	Art. - No. Art. no.	Referencia No. comparison no.	Longitud length	Ejecución execution	Precio price
IVECO Daily	084 302 302		2000 mm		a petición on request
	084 302 304		4000 mm		
	084 305 302		2000 mm		on request
	084 305 304		4000 mm		



ALUMBRADO LATERAL

Side-marker lamps

4 polos Superseal 4-pole Superseal

4 polos prolongadores - 4-pole extension

**4 polos prolongador para las lámparas de señalización laterales.
Otras longitudes disponibles a petición.**

4-pole extension for the side-marker lamp.
Further lengths on request.



adaptado para fits for	Art. - No. Art. no.	Referencia No. comparison no.	Longitud length	Ejecución execution	Precio price
IVECO Stralis	084 444 202		2000 mm	4 x 1,0 mm ² tubo ondulado 4 x 1,0 mm ² corrugated tube	a petición on request
	084 444 204		4000 mm		
	084 442 202		2000 mm	2 x 1,0 mm ² cable redondo 2 x 1,0 mm ² round cable	
	084 442 204		4000 mm		

Prolongadores en Y - Y-extension

**Cable alargador de 4 polos en forma Y para 2 luces de posición laterales.
Otras longitudes disponibles a petición.**

4-pole Y-extension for 2 side-marker lamps.
Further lengths on request.

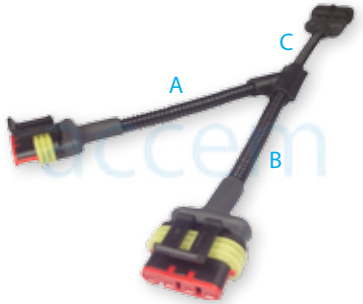

adaptado para fits for	Art. - No. Art. no.	Referencia No. comparison no.	A en mm A in mm	B en mm B in mm	C en mm C in mm	Precio price
IVECO Stralis	084 488 201		800	1800	200	a petición on request
	084 488 202		1800	1800	200	
	084 488 203		1800	2800	200	
	084 488 204		1800	3800	200	

Cable de alimentación en Y - Y-connecting cable

Cable de corexión de 4 polos en forma de Y con cable alargador de las luces de posición laterales y con una corexión adicional a otras 2 luces posición laterales. Otras longitudes disponibles a petición.

4-pole Y-connecting cable for the extension of the side-marker lamp and for additional connection of a 2. side-marker lamp. Further lengths on request.

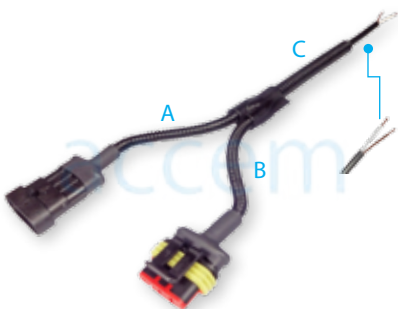



adaptado para fits for	Art. - No. Art. no.	Referencia No. comparison no.	A en mm	B en mm	C en mm	Ejecución execution	Precio price
IVECO Stralis	284 402 023		250	250	3000	2 x 1,0 mm ² cable redondo 2 x 1,0 mm ² round cable	a petición on request
	284 405 055		500	500	5000		
	384 402 023		250	250	3000	2 x 1,5 mm ² Aspöck P&R 2 x 1,5 mm ² Aspöck P&R	
	384 405 055		500	500	5000		

4 polos cable de alimentación - 4-pole connecting cable



Cable de alimentación de 4 polos para las luces de posición laterales con una caja de lápiz. Otras longitudes disponibles a petición.



4-pole connecting cable for the side-marker lamp with a pin housing. Further lengths on request.

adaptado para fits for	Art. - No. Art. no.	Referencia No. comparison no.	Longitud length	Ejecución execution	Precio price
IVECO Stralis	084 402 002		2000 mm	 2 x 1,0 mm ² cable redondo 2 x 1,0 mm ² round cable	a petición on request
	084 402 004		4000 mm		
	084 405 002		2000 mm	 2 x 1,5 mm ² Aspöck P&R 2 x 1,5 mm ² Aspöck P&R	
	084 405 004		4000 mm		

Cable de alimentación de 4 polos para 2 luces de posición laterales con una caja de lápiz. Otras longitudes disponibles a petición.

4-pole connecting cable for the left and the right side-marker lamp with a pin housing. Further lengths on request.





adaptado para fits for	Art. - No. Art. no.	Referencia No. comparison no.	Longitud length	Ejecución execution	Precio price
IVECO Stralis	084 402 202		2000 mm	 2 x 1,0 mm ² cable redondo 2 x 1,0 mm ² round cable	a petición on request
	084 402 204		4000 mm		
	084 405 202		2000 mm	 2 x 1,5 mm ² Aspöck P&R 2 x 1,5 mm ² Aspöck P&R	
	084 405 204		4000 mm		

4 polos cable de alimentación - 4-pole connecting cable



Cables de alimentación de 4 polos para las luces de posición laterales con una caja de hembrillas. Otras longitudes disponibles a petición.



4-pole connecting cable for the side-marker lamp with a socket housing. Further lengths on request.

adaptado para fits for	Art. - No. Art. no.	Referencia No. comparison no.	Longitud length	Ejecución execution	Precio price
IVECO Stralis	084 402 102		2000 mm	 2 x 1,0 mm ² cable redondo 2 x 1,0 mm ² round cable	a petición on request
	084 402 104		4000 mm		
	084 405 102		2000 mm	 2 x 1,5 mm ² Aspöck P&R 2 x 1,5 mm ² Aspöck P&R	
	084 405 104		4000 mm		

Cables de alimentación de 4 polos para 2 luces de posición laterales con una caja de hembrillas. Otras longitudes disponibles a petición.

4-pole connecting cable for the left and the right side-marker lamp with a socket housing. Further lengths on request.



adaptado para fits for	Art. - No. Art. no.	Referencia No. comparison no.	Longitud length	Ejecución execution	Precio price
IVECO Stralis	084 402 302		2000 mm	 2 x 1,0 mm ² cable redondo 2 x 1,0 mm ² round cable	a petición on request
	084 402 304		4000 mm		
	084 405 302		2000 mm	 2 x 1,5 mm ² Aspöck P&R 2 x 1,5 mm ² Aspöck P&R	
	084 405 304		4000 mm		



ALUMBRADO LATERAL

Side-marker lamps

4 polos Superseal 4-pole Superseal

4 polos cable de alimentación - 4-pole connecting cable



Cables de alimentación de 4 polos para 2 luces de posición laterales con una caja de hembrillas. Otras longitudes disponibles a petición.

4-pole connecting cable for 2 side-marker lamps with a socket housing. Further lengths on request.

adaptado para fits for	Art. - No. Art. no.	Referencia - No. comparison no.	Longitud length	Ejecución execution	Precio price
IVECO Eurocargo	184 402 202		2000 mm		2 x 1,0 mm ² cable redondo 2 x 1,0 mm ² round cable
	184 402 204		4000 mm		
	184 405 202		2000 mm		2 x 1,5 mm ² Aspöck P&R 2 x 1,5 mm ² Aspöck P&R
	184 405 204		4000 mm		

a petición on request

4 polos cable de alimentación - 4-pole connecting cable



Cables de alimentación de 4 polos para 2 luces de posición laterales con una caja de hembrillas. Otras longitudes disponibles a petición.

4-pole connecting cable for 2 side-marker lamps with a socket housing. Further lengths on request.

adaptado para fits for	Art. - No. Art. no.	Referencia - No. comparison no.	Longitud length	Ejecución execution	Precio price
IVECO Eurocargo	184 402 302		2000 mm		2 x 1,0 mm ² cable redondo 2 x 1,0 mm ² round cable
	184 402 304		4000 mm		
	184 405 302		2000 mm		2 x 1,5 mm ² Aspöck P&R 2 x 1,5 mm ² Aspöck P&R
	184 405 304		4000 mm		

a petición on request



adaptado para (fits for) MB Sprinter, div. ULO

2 polos cable de alimentación - 2-pole connecting cable



Cables de alimentación de 3 polos para las luces de posición laterales con una caja de hembrillas. Otras longitudes disponibles a petición.



2-pole connecting cable for a side-marker lamp with a socket housing. Further lengths on request.

adaptado para fits for	Art. - No. Art. no.	Referencia No. comparison no.	Longitud length	Ejecución execution	Precio price
div. ULO	084 022 022		2000 mm		a petición on request
	084 022 024		4000 mm		
	084 025 022		2000 mm		
	084 025 024		4000 mm		



Cables de alimentación de 3 polos para 2 luces de posición laterales con una caja de hembrillas. Otras longitudes disponibles a petición.

2-pole connecting cable for 2 side-marker lamps with a socket housing. Further lengths on request.



adaptado para fits for	Art. - No. Art. no.	Referencia No. comparison no.	Longitud length	Ejecución execution	Precio price
div. ULO	084 022 222		2000 mm		a petición on request
	084 022 224		4000 mm		
	084 025 222		2000 mm		
	084 025 224		4000 mm		

3 polos cable de alimentación - 3-pole connecting cable



Cable de alimentación de 3 polos para las luces de posición laterales con una caja de lápiz. Otras longitudes disponibles a petición.



3-pole connecting cable for a side-marker lamp with a pin housing. Further lengths on request.

adaptado para fits for	Art. - No. Art. no.	Referencia No. comparison no.	Longitud length	Ejecución execution	Precio price
MB Sprinter	184 502 002		2000 mm		a petición on request
	184 502 004		4000 mm		
	184 505 002		2000 mm		
	184 505 004		4000 mm		



Cable de alimentación de 3 polos para 2 luces de posición laterales con una caja de lápiz. Otras longitudes disponibles a petición.

3-pole connecting cable for 2 side-marker lamps with a pin housing. Further lengths on request.

adaptado para fits for	Art. - No. Art. no.	Referencia No. comparison no.	Longitud length	Ejecución execution	Precio price
MB Sprinter	184 502 202		2000 mm		a petición on request
	184 502 204		4000 mm		
	184 505 202		2000 mm		
	184 505 204		4000 mm		

ABS, EBS, 15 polos, N/S Prolongadores

Este grupo de productos incluye prolongadores, cables de conexión y prolongadores en Y. Nosotros podemos realizar variaciones específicas a petición.

ABS, EBS, 15-pole, N/S - EXTENSIONS

This product line includes extensions, connecting cables and Y-extensions. We generate and manufacture custom-specific variations.





ABS, EBS, 15 polos, N/S

ABS, EBS, 15-pole, N/S

Prolongadores extensions

5 polos ABS prolongadores 24 V - 5-pole ABS extension 24 V



Cable alargador de 5 polos (3 x 1,5 mm² + 2 x 4 mm²) 24 V PUR con cierre de conductor. Otras longitudes disponibles a petición.

5-pole ABS extension (3 x 1,5 mm² + 2 x 4 mm²) 24 V PUR with single sealed conductors. Further lengths on request.

Art. - No. Art. no.	Longitud length	Precio price
083 310 100	1000 mm	a petición on request
083 310 150	1500 mm	
083 310 200	2000 mm	
083 310 250	2500 mm	
083 310 300	3000 mm	

7 polos EBS prolongadores 24 V - 7-pole EBS extension 24 V



Cable alargador de 7 polos (5 x 1,5 mm² + 2 x 4 mm²) 24 V PUR con cierre de conductor. Otras longitudes disponibles a petición.

7-pole EBS extension (5 x 1,5 mm² + 2 x 4 mm²) 24 V PUR with single sealed conductors. Further lengths on request.

Art. - No. Art. no.	Longitud length	Precio price
083 510 100	1000 mm	a petición on request
083 510 150	1500 mm	
083 510 200	2000 mm	
083 510 250	2500 mm	
083 510 300	3000 mm	

15 polos prolongadores 24 V - 15-pole extension 24V



Cable alargador de 15 polos (12 x 1,5 mm² + 3 x 2,5 mm²) 24 V PUR con cierre de conductor. Otras longitudes disponibles a petición.

15-pole extension (12 x 1,5 mm² + 3 x 2,5 mm²) 24 V PUR with single sealed conductors. Further lengths on request.

Art. - No. Art. no.	Longitud length	Precio price
083 515 100	1000 mm	a petición on request
083 515 150	1500 mm	
083 515 200	2000 mm	
083 515 250	2500 mm	
083 515 300	3000 mm	

Cable en espiral spiral lines

5 polos ABS cable en espiral 12 V - 5-pole ABS spiral cable 12 V



Cable en espiral ABS de 5 polos (3 x 1,5 mm² + 2 x 4 mm²) 12 V PUR con un diametro de la espiral de 35 mm.

5-pole ABS spiral cable (3 x 1,5 mm² + 2 x 4 mm²) 12 V PUR with a diameter of the spiral of 35 mm.

Art. - No. Art. no.	Longitud length	Precio price
880 513 240	4500 mm	a petición on request

7 polos EBS cable en espiral 24 V - 7-pole EBS spiral cable 24 V



Cable en espiral EBS de 7 polos (5 x 1,5 mm² + 2 x 4 mm²) 24 V PUR con un diametro de la espiral de 35 mm.

7-pole EBS spiral cable (5 x 1,5 mm² + 2 x 4 mm²) 24 V PUR with a diameter of the spiral of 35 mm.

Art. - No. Art. no.	longitud length	Precio price
880 702 345	4500 mm	a petición on request

15 polos cable en espiral 24 V - 15-pole spiral cable 24 V



Cable en espiral de 15 polos (12 x 1,5 mm² + 3 x 2,5 mm²) 24 V PUR con un diametro de la espiral de 35 mm.

15-pole spiral cable (12 x 1,5 mm² + 3 x 2,5 mm²) 24 V PUR with a diameter of the spiral of 35 mm.

Art. - No. Art. no.	Longitud length	Precio price
881 502 345	4500 mm	a petición on request



ABS, EBS, 15 polos, N/S

ABS, EBS, 15-pole, N/S

Cables de conexión connecting cable

con 2 clavijas - with 2 plugs



Cable de conexión (con 2 clavijas) 24 V PUR para ABS, EBS o 15 polos.
Otras longitudes disponibles a petición.

Connecting cable (with 2 plugs) 24 V PUR for ABS, EBS or 15-pole.
 Further lengths on request.

Ejecución execution	Art. - No. Art. no.	Longitud length	Precio price
ABS	383 310 100	1000 mm	a petición on request
	383 310 150	1500 mm	
	383 310 200	2000 mm	
	383 310 250	2500 mm	
	383 310 300	3000 mm	
EBS	383 510 100	1000 mm	a petición on request
	383 510 150	1500 mm	
	383 510 200	2000 mm	
	383 510 250	2500 mm	
	383 510 300	3000 mm	
15 polos	383 515 100	1000 mm	a petición on request
	383 515 150	1500 mm	
	383 515 200	2000 mm	
	383 515 250	2500 mm	
	383 515 300	3000 mm	

con 2 tomas de corriente - with 2 sockets



Cable de conexión (con 2 tomas de corriente) 24 V PUR para ABS, EBS o 15 polos.
Otras longitudes disponibles a petición.

Connecting cable (with 2 sockets) 24 V PUR for ABS, EBS or 15-pole.
 Further lengths on request.

Ejecución execution	Art. - No. Art. no.	Longitud length	Precio price
ABS	583 310 100	1000 mm	a petición on request
	583 310 150	1500 mm	
	583 310 200	2000 mm	
	583 310 250	2500 mm	
	583 310 300	3000 mm	
EBS	583 510 100	1000 mm	a petición on request
	583 510 150	1500 mm	
	583 510 200	2000 mm	
	583 510 250	2500 mm	
	583 510 300	3000 mm	
15 polos	583 515 100	1000 mm	a petición on request
	583 515 150	1500 mm	
	583 515 200	2000 mm	
	583 515 250	2500 mm	
	583 515 300	3000 mm	

Cable listo para conexión connecting cable

con 1 clavija - with 1 plug



Cable listo para conexión (con 1 clavija) 24 V PUR para ABS, EBS o 15 polos.
Otras longitudes disponibles a petición.

Connecting cable (with 1 plug) 24 V PUR for ABS, EBS or 15-pole.
 Further lengths on request.

Ejecución execution	Art. - No. Art. no.	Longitud length	Precio price
ABS	083 330 100	1000 mm	a petición on request
	083 330 150	1500 mm	
	083 330 200	2000 mm	
	083 330 250	2500 mm	
	083 330 300	3000 mm	
EBS	083 530 100	1000 mm	a petición on request
	083 530 150	1500 mm	
	083 530 200	2000 mm	
	083 530 250	2500 mm	
	083 530 300	3000 mm	
15 polos	083 535 100	1000 mm	a petición on request
	083 535 150	1500 mm	
	083 535 200	2000 mm	
	083 535 250	2500 mm	
	083 535 300	3000 mm	

con 1 toma de corriente - with 1 socket



Cable listo para conexión (con 1 toma de corriente) 24 V PUR para ABS, EBS o 15 polos.
Otras longitudes disponibles a petición.

Connecting cable (with 1 socket) 24 V PUR for ABS, EBS or 15-pole.
 Further lengths on request.

Ejecución execution	Art. - No. Art. no.	Longitud length	Precio price
ABS	083 320 100	1000 mm	a petición on request
	083 320 150	1500 mm	
	083 320 200	2000 mm	
	083 320 250	2500 mm	
	083 320 300	3000 mm	
EBS	083 520 100	1000 mm	a petición on request
	083 520 150	1500 mm	
	083 520 200	2000 mm	
	083 520 250	2500 mm	
	083 520 300	3000 mm	
15 polos	083 525 100	1000 mm	a petición on request
	083 525 150	1500 mm	
	083 525 200	2000 mm	
	083 525 250	2500 mm	
	083 525 300	3000 mm	



ABS, EBS, 15 polos, N/S

ABS, EBS, 15-pole, N/S

Cable adaptador cableadapter

Y-EBS - Y-EBS

ISO 7638-1



Cable adaptador 24 V PUR con una clavija de 7 polos EBS y 2 tomas de corriente de 7 polos EBS. Otras longitudes disponibles a petición.

Cableadapter 24 V PUR with a 7-pole EBS plug and 2 x 7-pole EBS sockets. Further lengths on request.

Art. - No. Art. no.	Longitud length	Longitud length	Precio price
283 510 051 0	500 mm	1000 mm	a petición on request
283 510 101 0	1000 mm	1000 mm	
283 510 202 0	2000 mm	2000 mm	
283 510 303 0	3000 mm	3000 mm	

Y-15 polos - Y-15-pole

ISO 12098



Cable adaptador 24 V PUR con una clavija de 15 polos y 2 tomas de corriente de 15 polos. Otras longitudes disponibles a petición.

Cableadapter 24 V PUR with a 15-pole plug and 2 x 15-pole sockets. Further lengths on request.

Art. - No. Art. no.	Longitud length	Longitud length	Precio price
283 515 051 0	500 mm	1000 mm	a petición on request
283 515 101 0	1000 mm	1000 mm	
283 515 202 0	2000 mm	2000 mm	
283 515 303 0	3000 mm	3000 mm	

15 polos en 15 polos + N/S - 15-pole at 15-pole + N/S

**ISO 12098,
ISO 1185 + ISO 3731**



Cable adaptador 24 V PUR con una clavija de 15 polos, una toma de corriente de 15 polos y 2 tomas de corriente de 7 polos Typ N/S. Otras longitudes disponibles a petición.

Cableadapter 24 V PUR with a 15-pole plug, a 15-pole socket and 2 x 7-pole sockets type N/S. Further lengths on request.

Art. - No. Art. no.	Longitud 15 polos lengths 15-pole	Longitud N length N	Longitud S Length S	Precio price
283 505 05NS	500 mm	1000 mm	1000 mm	a petición on request
283 510 10NS	1000 mm	1000 mm	1000 mm	
283 520 20NS	2000 mm	2000 mm	2000 mm	
283 530 30NS	3000 mm	3000 mm	3000 mm	

15 polos en N/S - 15-pole at N/S

**ISO 12098,
ISO 1185 + ISO 3731**



Cable adaptador 24 V PUR con una clavija de 15 polos y 2 tomas de corriente de 7 polos Typ N/S. Otras longitudes disponibles a petición.

Cableadapter 24 V PUR with a 15-pole plug and 2 x 7-pole sockets type N/S. Further lengths on request.

Art. - No. Art. no.	Longitud N length N	Longitud S length S	Precio price
283 005 05NS	500 mm	500 mm	a petición on request
283 010 10NS	1000 mm	1000 mm	
283 020 20NS	2000 mm	2000 mm	
283 030 30NS	3000 mm	3000 mm	

Y-15 polos - br/sw - Y-15-pole - br/bl

ISO 12098



Cable adaptador 24 V PUR/PA6 con toma de corriente de 15 polos y 2 bases de enchufe br/sw de 8 polos. Otras longitudes disponibles a petición.

Cableadapter 24 V PUR/PA6 with a 15-pole socket and 2 x 8-pole pin housing br/bl. Further lengths on request.

Art. - No. Art. no.	Referencia No. comparison no.	Longitud length	Precio price
283 205 150	81.25432-6177	1500 mm	a petición on request
283 205 250		2500 mm	
283 205 350		3500 mm	

15 polos - N/S adaptador - 15-pole - N/S adapterISO 12098,
ISO 1185 + ISO 3731

Adaptador de toma de corriente de 15 polos 24 V a 2 conectores de 7 polos 24 V Typ N/S.

Adapter of 15-pole 24 V socket on 2 x 7-pole 24 V plugs type N/S.

Art. - No. Art. no.	Precio price
651 577 191	a petición on request

Cable en espiral de 7 polos Typ S - 7-pole spiral cable type S

ISO 3731



Cable en espiral de 7 polos (6 x 1,0 mm² + 1 x 1,5 mm²) 24 V PUR Typ S con un diametro de espiral de 20 mm.

7-pole spiral cable (6 x 1,0 mm² + 1 x 1,5 mm²) 24 V PUR type S with a diameter of the spiral of 20 mm.

Art. - No. Art. no.	Longitud length	Precio price
881 702 145	4500 mm	a petición on request

Cable en espiral de 7 polos Typ N - 7-pole spiral cable type N

ISO 1185



Cable en espiral de 7 polos (6 x 1,0 mm² + 1 x 1,5 mm²) 24 V PUR Typ N con un diametro de espiral de 20 mm.

7-pole spiral cable (6 x 1,0 mm² + 1 x 1,5 mm²) 24 V PUR type N with a diameter of the spiral of 20 mm.

Art. - No. Art. no.	Longitud length	Precio price
881 702 045	4500 mm	a petición on request



ABS, EBS, 15 polos, N/S

ABS, EBS, 15-pole, N/S

Prolongadores extensions

8 polos prolongadores marrón S - 8-pole extension brown S



Cable alargador marrón de 8 polos (S) con una caja de lapiz e caja de hembrillas. Otras longitudes disponibles a petición.

8-pole extension brown (S) with a pin housing and a socket housing. Further lengths on request.

adaptado para fits for	Art. - No. Art. no.	Referencia No. comparison no.	Longitud length	Precio price
MANTG	083 810 050		500 mm	a petición on request
	083 810 100	81.25428-6973	1000 mm	
	083 810 150	81.25428-6974	1500 mm	

8 polos prolongadores en Y marrón S - 8-pole Y-extension brown S



Cable alargador marrón en forma Y de 8 polos (S) con una caja de lapiz de 8 polos e 2 caja de hembrillas a 8 polos. Otras longitudes disponibles a petición.

Y-extension brown (S) with a 8-pole pin housing and 2 x 8-pole socket housing. Further lengths on request.

adaptado para fits for	Art. - No. Art. no.	Referencia No. comparison no.	Longitud length	Precio price
MANTG	283 810 050	81.25432-6174	500 mm	a petición on request
	283 810 100		1000 mm	
	283 810 200		2000 mm	
	283 810 300		3000 mm	

7 polos Typ 24 S prolongadores - 7-pole type 24 S extension



Enchufe de 7 polos Typ 24 S a caja de lapiz de 8 polos marrón. Otras longitudes disponibles a petición.

7-pole socket type 24 S on 8-pole pin housing brown. Further lengths on request.

adaptado para fits for	Art. - No. Art. no.	Referencia No. comparison no.	Longitud length	Precio price
MANTG	S83 810 100		1000 mm	a petición on request
	S83 810 150		1500 mm	
	S83 810 200	81.25432-6202	2000 mm	
	S83 810 250		2500 mm	
	S83 810 300		3000 mm	

7 polos Typ 24 S prolongadores - 7-pole type 24 S extension



Enchufe de 7 polos Typ 24 S a clavija de 7 polos Typ 24 S. Otras longitudes disponibles a petición.

7-pole socket type 24 S on 7-pole plug type 24 S. Further lengths on request.

Art. - No. Art. no.	Longitud length	Precio price
E 032 432 010	1000 mm	a petición on request
E 032 432 015	1500 mm	
E 032 432 020	2000 mm	
E 032 432 025	2500 mm	
E 032 432 030	3000 mm	

8 polos prolongadores negro N - 8-pole extension black N



Cable alargador negro de 8 polos (N) con una caja de lápiz e caja de hembrillas.
 Otras longitudes disponibles a petición.

8-pole extension black (N) with a pin housing and a socket housing.
 Further lengths on request.

adaptado para fits for	Art. - No. Art. no.	Referencia No. comparison no.	Longitud length	Precio price
	083 820 050		500 mm	
MAN TG	083 820 100	81.25428-6971	81254286971	1000 mm
	083 820 150	81.25428-6972	81254286972	1500 mm

a petición on request

8 polos prolongadores en Y negro N - 8-pole Y-extension black N



Cable alargador negro en forma Y de 8 polos (N) con una caja de lápiz de 8 polos e 2 caja de hembrillas a 8 polos. Otras longitudes disponibles a petición.

Y-extension black (N) with a 8-pole pin housing and 2 x 8-pole socket housing.
 Further lengths on request.

adaptado para fits for	Art. - No. Art. no.	Referencia No. comparison no.	Longitud length	Precio price
	283 820 050	81.25432-6173	81254326173	500 mm
MAN TG	283 820 100			1000 mm
	283 820 200			2000 mm
	283 820 300			3000 mm

a petición on request

7 polos Typ 24 N prolongadores - 7-pole type 24 N extension



Enchufe de 7 polos Typ 24 N a caja de lápiz de 8 polos negro. Otras longitudes disponible a petición.

7-pole socket type 24 N on 8-pole pin housing black. Further lengths on request.

adaptado para fits for	Art. - No. Art. no.	Referencia No. comparison no.	Longitud length	Precio price
	N83 820 100			1000 mm
	N83 820 150			1500 mm
MAN TG	N83 820 200	81.25432-6201	81254326201	2000 mm
	N83 820 250			2500 mm
	N83 820 300			3000 mm

a petición on request

7 polos Typ 24 N prolongadores - 7-pole type 24 N extension



Enchufe de 7 polos Typ 24 N a clavija de 7 polos Typ 24 N. Otras longitudes disponibles a petición.

7-pole socket type 24 N on 7-pole plug type 24 N. Further lengths on request.

Art. - No. Art. no.	Longitud length	Precio price
E 032 431 010	1000 mm	
E 032 431 015	1500 mm	
E 032 431 020	2000 mm	
E 032 431 025	2500 mm	
E 032 431 030	3000 mm	

a petición on request

NATO

**Este grupo de productos incluye cables de conexión, cables para puentes etc.
Nosotros podemos realizar variaciones específicas a petición.**

NATO

**This product line includes connecting cables, foreign jump lead etc.
We generate and manufacture custom-specific variations.**





NATO

NATO

NATO VG 96917

Cable de conexión - connecting cable

VG 96917



Cable de conexión de 2 polos Nato VG 96917 con 2 enchufes Nato con tuerca y una base de acoplamiento con tapa de roscada. Otras longitudes disponibles a petición.

2-pole Nato VG 96917 connecting cable with 2 Nato-plugs with ring nut and a coupling with screw caps. Further lengths on request.

Art. - No. Art. no.	Corte a través cross-section	Longitud length	Precio price
656 228 335	2 x 35 mm ²	3500 mm	a petición on request
656 228 360	2 x 35 mm ²	6000 mm	
656 228 380	2 x 35 mm ²	8000 mm	
656 228 310	2 x 35 mm ²	10000 mm	
656 228 315	2 x 35 mm ²	15000 mm	
656 228 320	2 x 35 mm ²	20000 mm	
656 228 325	2 x 35 mm ²	25000 mm	
<hr/>			
656 228 535	2 x 50 mm ²	3500 mm	a petición on request
656 228 560	2 x 50 mm ²	6000 mm	
656 228 580	2 x 50 mm ²	8000 mm	
656 228 510	2 x 50 mm ²	10000 mm	
656 228 515	2 x 50 mm ²	15000 mm	
656 228 520	2 x 50 mm ²	20000 mm	
656 228 525	2 x 50 mm ²	25000 mm	

Cable de conexión - connecting cable

VG 96917



Cable de conexión de 2 polos Nato VG 96917 con 2 enchufes-flavijas no endenecidos con tuerca y una base de acoplamiento no endurecida con tuerca. Otras longitudes disponibles a petición.

2-pole Nato VG 96917 connecting cable with 2 molded Nato-plugs with ring nut and a molded coupling with screw cap. Further lengths on request.

Art. - No. Art. no.	Corte a través cross-section	Longitud length	Precio price
656 227 335	2 x 35 mm ²	3500 mm	a petición on request
656 227 360	2 x 35 mm ²	6000 mm	
656 227 380	2 x 35 mm ²	8000 mm	
656 227 310	2 x 35 mm ²	10000 mm	
656 227 315	2 x 35 mm ²	15000 mm	
656 227 320	2 x 35 mm ²	20000 mm	
656 227 325	2 x 35 mm ²	25000 mm	
<hr/>			
656 227 535	2 x 50 mm ²	3500 mm	a petición on request
656 227 560	2 x 50 mm ²	6000 mm	
656 227 580	2 x 50 mm ²	8000 mm	
656 227 510	2 x 50 mm ²	10000 mm	
656 227 515	2 x 50 mm ²	15000 mm	
656 227 520	2 x 50 mm ²	20000 mm	
656 227 525	2 x 50 mm ²	25000 mm	

Cable de conexión - connecting cable
VG 96917

Cable de conexión de 2 polos Nato VG 96917 con 2 enchufes y una base de acoplamiento. Otras longitudes disponibles a petición.

2-pole Nato VG 96917 connecting cable with 2 Nato-plugs and a coupling.
Further lengths on request.

Art. - No. Art. no.	Corte a través cross-section	Longitud length	Precio price
656 229 335	2 x 35 mm ²	3500 mm	a petición on request
656 229 360	2 x 35 mm ²	6000 mm	
656 229 380	2 x 35 mm ²	8000 mm	
656 229 310	2 x 35 mm ²	10000 mm	
656 229 315	2 x 35 mm ²	15000 mm	
656 229 320	2 x 35 mm ²	20000 mm	
656 229 325	2 x 35 mm ²	25000 mm	
656 229 535	2 x 50 mm ²	3500 mm	a petición on request
656 229 560	2 x 50 mm ²	6000 mm	
656 229 580	2 x 50 mm ²	8000 mm	
656 229 510	2 x 50 mm ²	10000 mm	
656 229 515	2 x 50 mm ²	15000 mm	
656 229 520	2 x 50 mm ²	20000 mm	
656 229 525	2 x 50 mm ²	25000 mm	

Cable de conexión - connecting cable
VG 96917

Cable de conexión de 2 polos Nato VG 96917 con 2 torras de enchufes con tupa de rosca. Otras longitudes disponibles a petición.

2-pole Nato VG 96917 connecting cable with 2 Nato-sockets with ring nut.
Further lengths on request.

Art. - No. Art. no.	Corte a través cross-section	Longitud length	Precio price
656 223 335	2 x 35 mm ²	3500 mm	a petición on request
656 223 360	2 x 35 mm ²	6000 mm	
656 223 380	2 x 35 mm ²	8000 mm	
656 223 310	2 x 35 mm ²	10000 mm	
656 223 315	2 x 35 mm ²	15000 mm	
656 223 320	2 x 35 mm ²	20000 mm	
656 223 325	2 x 35 mm ²	25000 mm	
656 223 535	2 x 50 mm ²	3500 mm	a petición on request
656 223 560	2 x 50 mm ²	6000 mm	
656 223 580	2 x 50 mm ²	8000 mm	
656 223 510	2 x 50 mm ²	10000 mm	
656 223 515	2 x 50 mm ²	15000 mm	
656 223 520	2 x 50 mm ²	20000 mm	
656 223 525	2 x 50 mm ²	25000 mm	



NATO

NATO

NATO VG 96917

Cable en espiral - spiral cable

VG 96917



Cable en espiral de 2 polos Nato VG 96917 PUR 35 mm² con 2 enchufes Nato en goma con tuerca.

2-pole Nato VG 96917 spiral cable PUR 35 mm² with 2 gummed Nato-plug with ring nut.

Art. - No. Art. no.	Corte a través cross-section	Longitud length	Precio price
889 206 240	2 x 35 mm ²	4500 mm	a petición on request

Cable en espiral - spiral cable

VG 96917



Cable en espiral de 2 polos Nato VG 96917 PUR 35 mm² con 2 enchufes Nato con tuerca.

2-pole Nato VG 96917 spiral cable PUR 35 mm² with 2 Nato-plugs with ring nut.

Art. - No. Art. no.	Corte a través cross-section	Longitud length	Precio price
888 206 240	2 x 35 mm ²	4500 mm	a petición on request

Enchufe Nato - Nato-plug

VG 96917



Enchufe de 2 polos Nato VG 96917 incluido contacto. Ejecución con o sin tuerca (TU).

2-pole Nato VG 96917 plug including contacts. Execution with or without ring nut (RN).

Art. - No. Art. no.	Corte a través cross-section	Ejecución execution	Precio price
656 222 365	35 - 50 mm ²	verde - con TU	green - with RN
656 220 365	35 - 50 mm ²	verde - sin TU	green - without RN
656 221 365	35 - 50 mm ²	negro - sin TU	black - without RN
656 224 365	35 - 50 mm ²	negro - plástico - sin TU	black - plastic - without RN
656 227 365	35 - 50 mm ²	negro - goma - con TU	black - gummed - with RN

a petición
on request

Toma de enchufe Nato - Nato-socket

VG 96917



Toma de enchufe de 2 polos Nato VG 96917 incluido contacto.

2-pole Nato VG 96917 socket including contacts.

Art. - No. Art. no.	Corte a través cross-section	Ejecución execution	Precio price
656 220 383	35 mm ² , 50 mm ²	verde	green
656 222 383	35 mm ² , 50 mm ²	amarillo	yellow
656 221 383	35 mm ² , 50 mm ²	negro	black
656 224 383	35 mm ² , 50 mm ²	negro - plástico	black - plastic

a petición
on request

Toma de enchufe con cable - socket with cable

VG 96917



Toma de enchufe de 2 polos con cable listo para la conexión y un protector de cable PA6. Para una arandela de goma premontados [Art.-No. + "G"]. p. ej.: "656 220 308 G". Otras longitudes disponibles a petición.

2-pole Nato-socket with a ready for connection cable and cable protection PA6. For a pre-assembled rubber grommet [art. no. + "G"]. Example: "656 220 308 G". Further lengths on request.

Art. - No. Art. no.	Corte a través cross-section	Longitud length	Precio price
656 220 308	2 x 35 mm ²	800 mm	a petición on request
656 220 320	2 x 35 mm ²	2000 mm	
656 220 330	2 x 35 mm ²	3000 mm	
656 220 340	2 x 35 mm ²	4000 mm	
656 220 350	2 x 35 mm ²	5000 mm	
656 220 508	2 x 50 mm ²	800 mm	a petición on request
656 220 520	2 x 50 mm ²	2000 mm	
656 220 530	2 x 50 mm ²	3000 mm	
656 220 540	2 x 50 mm ²	4000 mm	
656 220 550	2 x 50 mm ²	5000 mm	

opcional premontados
optional pre-assembled

Angular universal para montaje - universal mounting bracket

Angular universal para montaje para ABS, EBS, 15 polos e enchufe de Nato.

Universal mounting bracket for ABS, EBS, 15-pole and Nato-sockets.

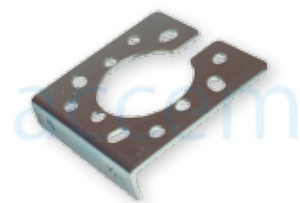

Art. - No. Art. no.	Material material	Precio price
037 001 002	acero - cincado en azul steel - blue zincd	a petición on request
037 001 003	acero - Niro steel - stainless steel	

Arandela de goma - rubber grommet

VG 96917



Arandela de goma de 2 polos para toma de enchufe Nato VG 96917 adaptado para cable (D 9,9 - 11,75 mm) y tubo ondulado (AN 13).

2-pole rubber grommet for Nato VG 96917 socket fits for cable (D 9,9 - 11,75 mm) and corrugated pipe (NW 13).

Art. - No. Art. no.	Precio price
030 656 383	a petición on request



NATO

NATO

Cables para puentes jump leads

Cables para puentes Nato - Nato jump lead

VG 96917



Cables para puente de 2 polos Nato VG 96917 con 2 pintas de acero aislados totalmente 600 A con polos de acero insertados y cinta de corbe y enchufe Nato. Otras longitudes disponibles a petición.

2-pole Nato VG 96917 jump lead with 2 all-insulated 600 A steel plate pliers with cast pole inserts and CU-band and 1 Nato-plug. Further lengths on request.

Art. - No. Art. no.	Corte a través cross-section	Longitud length	Precio price
656 225 335	2 x 35 mm ²	3500 mm	
656 225 350	2 x 35 mm ²	5000 mm	a petición on request
656 225 360	2 x 35 mm ²	6000 mm	
656 225 535	2 x 50 mm ²	3500 mm	
656 225 550	2 x 50 mm ²	5000 mm	a petición on request
656 225 560	2 x 50 mm ²	6000 mm	

Cables para puentes abierto - jump lead open

VG 96917



Cable para puente de 2 polos con 2 pintas de acero aislados totalmente 600 A con polos de acero insertados y cinta de corbe el otro externo abierto. Otras longitudes disponibles a petición.

2-pole jump lead with 2 all-insulated 600 A steel plate pliers with cast pole inserts and CU-band and open end. Further lengths on request.

Art. - No. Art. no.	Corte a través cross-section	Longitud length	Precio price
E 830 635 635	2 x 35 mm ²	3500 mm	
E 830 635 650	2 x 35 mm ²	5000 mm	a petición on request
E 830 635 660	2 x 35 mm ²	6000 mm	
E 830 650 635	2 x 50 mm ²	3500 mm	
E 830 650 650	2 x 50 mm ²	5000 mm	a petición on request
E 830 650 660	2 x 50 mm ²	6000 mm	

Cables para puentes - jump lead

VG 96917



Cable para puente de 2 polos con 4 pintas de acero aislados totalmente 600 A con polos de acerp insertados y cinta de corbe. Otras longitudes disponibles a petición.

2-pole jump lead with 4 all-insulated 600 A steel plate pliers with cast pole inserts and Cu-band. Further lengths on request.

Art. - No. Art. no.	Corte a través cross-section	Longitud length	Precio price
830 635 635	2 x 35 mm ²	3500 mm	
830 635 650	2 x 35 mm ²	5000 mm	a petición on request
830 635 660	2 x 35 mm ²	6000 mm	
830 650 635	2 x 50 mm ²	3500 mm	
830 650 650	2 x 50 mm ²	5000 mm	a petición on request
830 650 660	2 x 50 mm ²	6000 mm	

Cables para puentes girado jump leads cranked

Cables para puentes girado Nato - Nato jump lead cranked

VG 96917



2 cables para puentes de 2 polos con 2 alicates girados completamente aislados de 900 A y cinta de corbe y 1 clavija Nato. Otras longitudes disponibles a petición.

2-pole Nato VG 96917 jump lead with 2 cranked all-insulating 900 A full-cast pliers and CU-band and 1 Nato-plug. Further lengths on request.

Art. - No. Art. no.	Corte de través cross-section	Longitud length	Precio price
656 225 335 G	2 x 35 mm ²	3500 mm	a petición on request
656 225 350 G	2 x 35 mm ²	5000 mm	
656 225 360 G	2 x 35 mm ²	6000 mm	
656 225 535 G	2 x 50 mm ²	3500 mm	a petición on request
656 225 550 G	2 x 50 mm ²	5000 mm	
656 225 560 G	2 x 50 mm ²	6000 mm	

Cables para puentes abierto girado - jump lead cranked open

VG 96917



Cables para puentes de 2 polos con 2 alicates girados completamente aislados de 900 A y cinta de corbe y el otro externo abierto. Otras longitudes disponibles a petición.

2-pole jump lead with 2 cranked all-insulating 900 A full-cast pliers and CU-band and open end. Further lengths on request.

Art. - No. Art. no.	Corte de través cross-section	Longitud length	Precio price
E 830 635 635 G	2 x 35 mm ²	3500 mm	a petición on request
E 830 635 650 G	2 x 35 mm ²	5000 mm	
E 830 635 660 G	2 x 35 mm ²	6000 mm	
E 830 650 635 G	2 x 50 mm ²	3500 mm	a petición on request
E 830 650 650 G	2 x 50 mm ²	5000 mm	
E 830 650 660 G	2 x 50 mm ²	6000 mm	

Cables para puentes girado - jump lead cranked

VG 96917



Cables para puentes de 2 polos con 4 alicates girados completamente aislados de 900 A y cinta de corbe. Otras longitudes disponibles a petición.

2-pole jump lead with 4 cranked all-insulating 900 A full-cast pliers and CU-band. Further lengths on request.

Art. - No. Art. no.	Corte de través cross-section	Longitud length	Precio price
830 635 635 G	2 x 35 mm ²	3500 mm	a petición on request
830 635 650 G	2 x 35 mm ²	5000 mm	
830 635 660 G	2 x 35 mm ²	6000 mm	
830 650 635 G	2 x 50 mm ²	3500 mm	a petición on request
830 650 650 G	2 x 50 mm ²	5000 mm	
830 650 660 G	2 x 50 mm ²	6000 mm	



NATO

NATO

Cables para puentes jump leads

Cables para puentes Nato - Nato jump lead

VG 96917



Cables para puente de 2 polos Nato VG 96917 con 2 pintas de acero aislados totalmente 600 A con polos de acero insertados y cinta de corbe y enchufe Nato con o sin tuerca.

Otras longitudes disponibles a petición.

2-pole Nato VG 96917 jump lead with 2 all-insulated 600 A steel plate pliers with cast pole inserts and CU-band and 1 Nato-plug. Further lengths on request.

Art. - No. Art. no.	Corte a través cross-section	Longitud length	Precio price
656 226 315	2 x 35 mm ²	1500 mm	
656 226 335	2 x 35 mm ²	3500 mm	a petición on request
656 226 350	2 x 35 mm ²	5000 mm	
656 226 360	2 x 35 mm ²	6000 mm	
656 226 513	2 x 50 mm ²	1500 mm	
656 226 535	2 x 50 mm ²	3500 mm	a petición on request
656 226 550	2 x 50 mm ²	5000 mm	
656 226 560	2 x 50 mm ²	6000 mm	

Cables para puentes girado jump leads cranked

Cables para puentes girado Nato - Nato jump lead cranked

VG 96917



2 cables para puentes de 2 polos con 2 alicates girados completamente aislados de 900 A y cinta de corbe y 1 clavija Nato con o sin tuerca.

Otras longitudes disponibles a petición.

2-pole Nato VG 96917 jump lead with 2 cranked all-insulating 900 A full-cast pliers and CU-band and 1 Nato-plug. Further lengths on request.

Art. - No. Art. no.	Corte de través cross-section	Longitud length	Precio price
656 226 315 G	2 x 35 mm ²	1500 mm	a petición on request
656 226 335 G	2 x 35 mm ²	3500 mm	
656 226 350 G	2 x 35 mm ²	5000 mm	
656 226 360 G	2 x 35 mm ²	6000 mm	
656 226 513 G	2 x 50 mm ²	1500 mm	a petición on request
656 226 535 G	2 x 50 mm ²	3500 mm	
656 226 550 G	2 x 50 mm ²	5000 mm	
656 226 560 G	2 x 50 mm ²	6000 mm	

Otros juego de cables

Este grupo de productos incluye, prolongadores para válvula magnética, sensores, medidor del nivel de combustible, etc.

Nosotros podemos realizar variaciones específicas a petición.

VARIOUS CABLE SETS

This product line includes, extensions for magnetic valve, sensors, tank encoder, plate light etc.
We generate and manufacture custom-specific variations.





OTROS JUEGO DE CABLES

various cable sets

Medidor del nivel de combustible, sensores tank encoder, sensors

4 polos prolongadores 90° - 4-pole extension 90°



Cable alargador de 4 polos para las válvulas, sensores y medidor del nivel de combustible. Otras longitudes disponibles a petición.

4-pole extension for valve block, sensors, tank encoder, ... Further lengths on request.

adaptado para fits for	Art. - No. Art. no.	Referencia No. comparison no.	Adaptador adapter	Longitud length	Precio price
MAN TG	085 200 001		90° / 180°	1000 mm	a petición on request
	085 200 002		90° / 180°	2000 mm	
	085 200 003		90° / 180°	3000 mm	
	085 200 004		90° / 180°	4000 mm	

4 polos prolongadores 180° - 4-pole extension 180°



Cable alargador de 4 polos para las válvulas, sensores y medidor del nivel de combustible. Otras longitudes disponibles a petición.

4-pole extension for valve block, sensors, tank encoder, ... Further lengths on request.

adaptado para fits for	Art. - No. Art. no.	Referencia No. comparison no.	Adaptador adapter	Longitud length	Precio price
MAN TG	085 288 001		2 x 180°	1000 mm	a petición on request
	085 288 002		2 x 180°	2000 mm	
	085 288 003		2 x 180°	3000 mm	
	085 288 004		2 x 180°	4000 mm	

4 polos prolongadores 2 x 90° - 4-pole extension 2 x 90°



Cable alargador de 4 polos para el medidor del nivel de combustible. Otras longitudes disponibles a petición.

4-pole extension for the tank encoder. Further lengths on request.

adaptado para fits for	Art. - No. Art. no.	Referencia No. comparison no.	Adaptador adapter	Longitud length	Precio price
IVECO Daily	085 400 001		2 x 90°	1000 mm	a petición on request
	085 400 002		2 x 90°	2000 mm	
	085 400 003		2 x 90°	3000 mm	
	085 400 004		2 x 90°	4000 mm	

4 polos prolongadores 180° - 4-pole extension 180°



Cable alargador de 4 polos para el sensor de la suspensión neumática. Otras longitudes disponibles a petición.

4-pole extension for sensor cushioning. Further lengths on request.

adaptado para fits for	Art. - No. Art. no.	Referencia No. comparison no.	Adaptador adapter	Longitud length	Precio price
MB Sprinter	085 588 005		2 x 180°	500 mm	a petición on request
	085 588 010		2 x 180°	1000 mm	
	085 588 020		2 x 180°	2000 mm	

3 polos prolongadores 180° - 3-pole extension 180°



Cable alargador de 2, 3 polos para la luz de matrícula. Incluye un juego de caja de enchufes de 2 polos, clavijas de contacto y tapones ciegos. Otras longitudes disponibles a petición.

2- (3-) pole extension for the plate light.
Including 2-pole socket housing, contacts and seals. Further lengths on request.

adaptado para fits for	Art. - No. Art. no.	Referencia No. comparison no.	Adaptador adapter	Longitud length	Precio price
IVECO Daily	086 444 060		90° / 180°	600 mm	a petición on request
	086 444 100		90° / 180°	1000 mm	
	086 444 160		90° / 180°	1600 mm	
	086 444 200		90° / 180°	2000 mm	
	086 444 300		90° / 180°	3000 mm	



Distribuidor - junction board



Distribuidor en 5 posibilidad de conexión: para caja de enchufe de 8 polos y enchufe de 37 polos con contactos.

Junction board with 5 possible connections: for 8-pole socket housing and 37-pole plug with contacts.

adaptado para fits for	Art. -No. Art. no.	Referencia No. comparison no.	Precio price	
MAN		81 25435 0523	81250350523	a petición on request

Adaptador - adapter



Adaptador (breve) de 7 polos 12 V en acoplo de 13 polos.

Adapter (short) 7-pole 12 V at 13-pole coupling.

Art. - No. Art. no.	Referencia No. comparison no.	Precio price
651 731 183		a petición on request

Adaptador - adapter



Adaptador (breve) de 13 polos 12 V en acoplo de 7 polos.

Adapter (short) 13-pole 12 V at 7-pole coupling.

Art. - No. Art. no.	Referencia No. comparison no.	Precio price
651 371 183		a petición on request

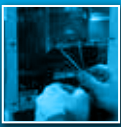

OTROS JUEGO DE CABLES

various cable sets

Cable de alimentación connection

16 polos cable de alimentación - 16 pole connection



16 polos caja de hembrillas para DAF Bodybuilder A 152 con 2m dirección.
16 pole socket housing for DAF Bodybuilder A 152 with 2m cable.

adaptado para fits for	Art. - No. Art. no.	Referencia No. comparison no.	Precio price
DAF Bodybuilder	183 016 201 C	AELF996	€ 47,00

a partir de € 47,00

16 polos HDSCS caja de hembrillas

1	9
2	10
3	11
4	12
5	13
6	14
7	15
8	16

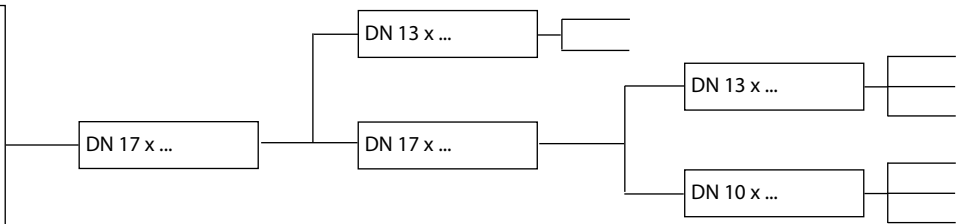

Ejemplo:

16 polos HDSCS caja de hembrillas

1_1,5 mm ² ge	9
2_2,5 mm ² ws	10
3	11
4	12
5	13
6	14
7	15
8	16

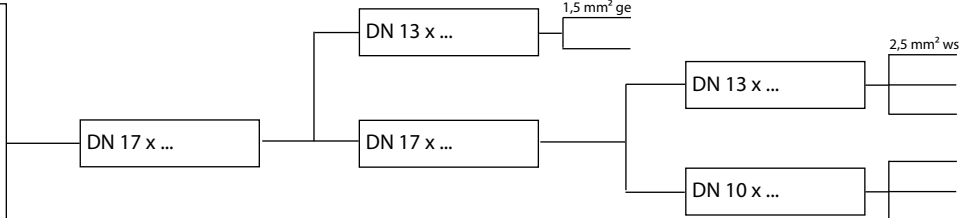

Leyenda de colores:

bl: azul/blue	ge: amarillo/yellow	gr: gris/grey	rt: rojo/red	vi: violeta/purple	rs: rosa/pink
br: marrón/brown	gn: verde/green	nt: natural/nature	sw: negro/black	ws: blanco/white	or: naranja/orange

Confección de cables - cable manufacturing

Modelos especiales, cables especiales

special model, special cable



Como servicio proveedor para una amplia gama de cables desde hace 30 años. Podemos realizar empalmes de cableado con tornillos, arandelas y enchufes a medida, tanto para varios sectores y como para diferentes áreas de aplicación.

Somo una empresa de tamaño medio y bastante flexibles. Empleamos nuestros automatismos y máquinas de fabricación de cableado como instrumento para fabricar contactos de cables como por ejemplo en la producción de piezas individuales para series más limitadas ó para modelos especiales.

Nuestro departamento de ventas junto con nuestro equipo, le puede acompañar desde el desarrollo del proyecto hasta su fabricación.

Ventajas para nuestros clientes

- 1 Alta calidad garantizada por colaborador con experiencia larga
- 2 Alta flexibilidad y rapidó ejecución del pedido
- 3 Breve plazo de entrega

As service provider in the range of cable sets we tailor cables for over 30 years with solder-, crimp- or bolted connection to measure for a lot of several sectors and application areas.

As a midsize company we are ultraflexible. We insert our automats and machines in the cable manufacturing as auxiliary material for cable processing, for construction of individual pieces, mini-series and special equipment.

Our distribution, together with our projectteam, accompany you with personally commitment from processing to production process.

Advantages for our clients

- 1 Best quality guaranteed by long-standing trouper
- 2 Top flexibility and fast order transaction
- 3 Short delivery times



OTROS JUEGO DE CABLES

various cable sets

accem - Automotive GmbH

Maderspergerstraße 10
4560 Kirchdorf/Krems
Österreich

office@accem.at
www.accem.at
TEL. +43 7582 / 61219 - 0
FAX. +43 7582 / 61219 - 30

Formulario de fax a pedido especial

Exhibición:

16 polos HDSCS caja de hembrillas

1	_____	9	_____
2	_____	10	_____
3	_____	11	_____
4	_____	12	_____
5	_____	13	_____
6	_____	14	_____
7	_____	15	_____
8	_____	16	_____

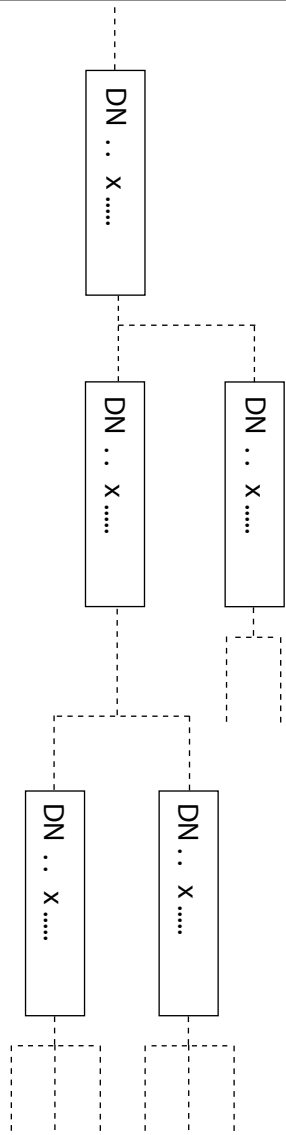

Ejemplo:

16 polos HDSCS caja de hembrillas

1	1,5 mm ² ge	9	_____
2	2,5 mm ² ws	10	_____
3	_____	11	_____
4	_____	12	_____
5	_____	13	_____
6	_____	14	_____
7	_____	15	_____
8	_____	16	_____

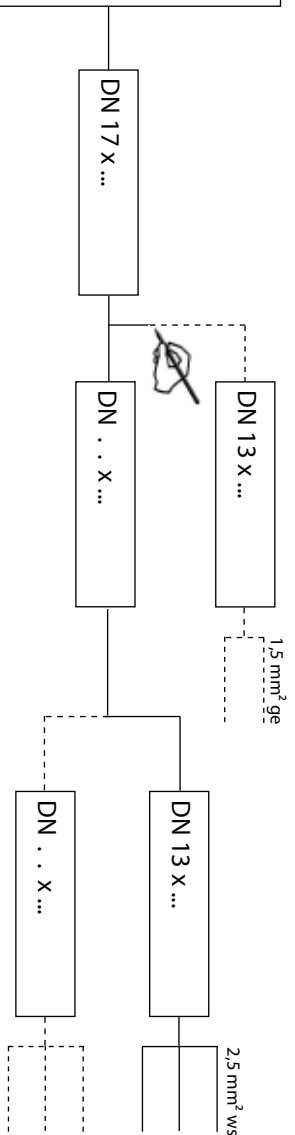



Protección para cables

Este grupo de productos incluye tubo ondulado, tubo aislante, tubo el plexo y accesorios.

CABLE PROTECTION

This product line includes corrugated pipe, insulating tube, braided sleeve and accessories.

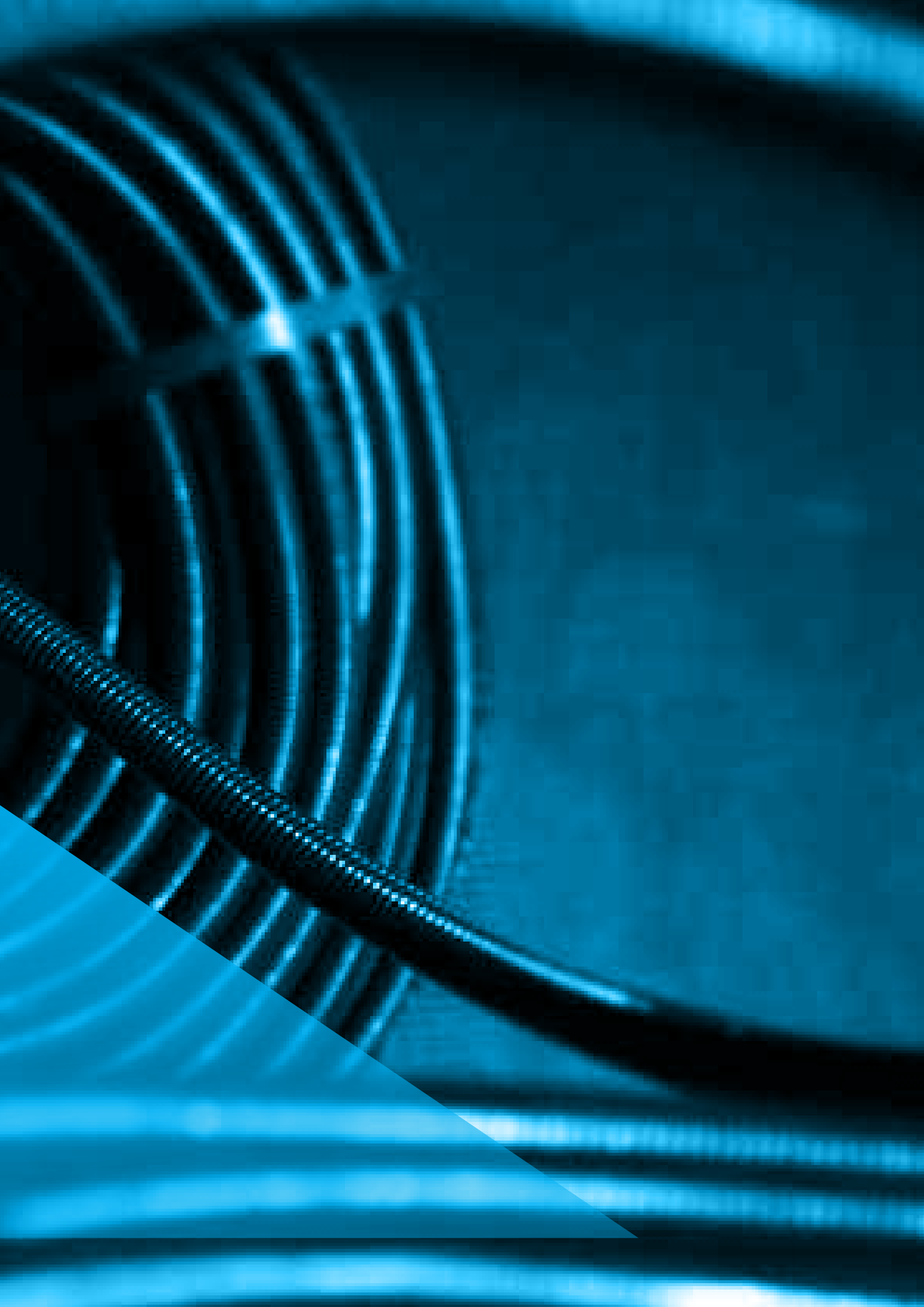



PROTECCIÓN PARA CABLES

Cable protection

Tubo ondulado corrugated tube

PA6 HB - PA6 HB

POLYFLEX®

PA6 HB

Perfil normal



POLYFLEX®

PA6 HB

Normal Profile

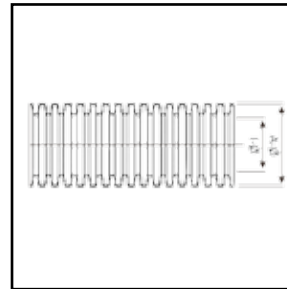

Material:

Poliamida 6

Rango de temperatures:

3000 h: -40°C a 120°C
240 h: -40°C a 150°C

Inflamabilidad:

- UL 94: HB
- a FMVSS 302: < 100mm/min

Color(es)/modelos:

- Negro, gris, otras a petición
- Longitudes a petición

Caraterísticas:

- No necesita ninguna cinta adhesiva de aislamiento para cables de alimentación y extremos de cables
- Resistente a UV conforme a DIN EN ISO 8580
- Libre de halógeno

Aplicaciones:

- Altas sobrecargas mecánicas
- Motores y carrocerías
- Máquinas conducción, general
- Industria naval y ferroviaria
- Armarios de control

Material:

Polyamide 6

Temperature range:

3000 h: -40°C to 120°C
240 h: -40°C to 150°C

Inflammability:

- UL 94: HB
- acc. to FMVSS 302: < 100mm/min

Colour(s)/Designs:

- Black, grey, others on request
- Cutted lengths on request

Characteristics:

- No wrapping tape necessary at cable feeders or cable ends
- UV resistant acc. to DIN EN ISO 8580
- Free of halogen

Applications:

- For high mechanical stresses
- Body section and chassis
- Construction machinery and machinery
- Ship- and trainbuilding
- Switch cabinet

DN	Ø A mm	Ø I mm	Art.-No. ranurado	Art. Nr. no ranurado	UE m	Precio
NW	Ø A mm	Ø I mm	Art. no slit	Art. no. unslit	PU m	price
4,5	7,1	5,0	014 120 104	014 120 204	100	
6	9,2	6,0	014 120 106	014 120 206	100	
7,5	10,0	6,7	014 120 107	014 120 207	50	
8,5	11,7	8,4	014 120 108	014 120 208	50	
10	13,0	9,9	014 120 110	014 120 210	50	
13	15,8	12,7	014 120 113	014 120 213	50	
17	21,2	16,6	014 120 117	014 120 217	50	
19	24,3	19,3	014 120 119	014 120 219	50	
22	25,4	21,3	014 120 122	014 120 222	50	
26	31,2	25,8	014 120 126	014 120 226	25	
29	34,5	29,0	014 120 129	014 120 229	25	
37	42,4	36,0	014 120 137	014 120 237	25	
50	54,0	47,7	014 120 150	014 120 250	25	

a petición
on request

PP - PP

POLYFLEX®

PP

Perfil normal



POLYFLEX®

PP

Normal Profile

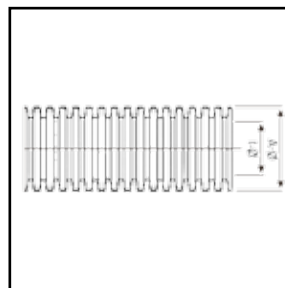

Material:
Polipropileno

Rango de temperaturas:
3000 h: -40°C a 105°C
350 h: -40°C a 135°C

Inflamabilidad:
• UL 94: HB
• a FMVSS 302:
< 100mm/min

Color(es)/modelos:
• Negro, otras a petición
• Longitudes a petición

Características:
• Alta resistencia al calor
• Gran capacidad ante el frío
• Alta tenacidad
• Estabilidad a la flexión
• Muy buena Resistencia química
• Resistente a UV conforme a DIN EN ISO 8580

Aplicaciones:
• Vehículos industriales
• AHW-Perfil: recomendado particularmente para pequeñas curvaturas

Material:
Polypropylene

Temperature range:
3000 h: -40°C to 105°C
350 h: -40°C to 135°C

Inflamability:
• UL 94: HB
• acc. to FMVSS 302:
< 100mm/min

Colour(s)/Designs:
• Black, others on request
• Cutted lengths on request

Characteristics:
• Great shape permanence to heat
• Enourmous cold impact strength
• High strength
• Bending stabile
• Excellent chemical resistance
• UV resistant acc. to DIN EN ISO 8580

Applications:
• Vehicle Industries
• AHW-Profile: for small bending radil recommended

DN	Ø A mm	Ø I mm	Art.-No. ranurado	Art. No. non ranurado	UE m	Precio
NW	Ø A mm	Ø I mm	Art. no slit	Art. no. unslit	PU m	price
4,5	7,1	5,0	014 100 104	014 100 204	100	a petición on request
6	9,2	6,0	014 100 106	014 100 206	100	
7,5	9,9	6,9	014 100 107	014 100 207	50	
8,5	11,6	8,5	014 100 108	014 100 208	50	
10	12,7	10,1	014 100 110	014 100 210	50	
13	15,8	12,9	014 100 113	014 100 213	50	
17	21,0	16,8	014 100 117	014 100 217	50	
19	24,0	19,4	014 100 119	014 100 219	50	
22	25,5	21,8	014 100 122	014 100 222	50	
26	31,3	26,4	014 100 126	014 100 226	25	
29	33,9	29,3	014 100 129	014 100 229	25	
37	42,0	36,7	014 100 137	014 100 237	25	



PROTECCIÓN PARA CABLES

Cable protection

Tubo ondulado corrugated tube

Duo-Flex PA6 HB - Duo-Flex PA6 HB



Duo-Flex PA6 HB

bipartito + Perfil con cierre



Duo-Flex PA6 HB

two piece + closable Profile

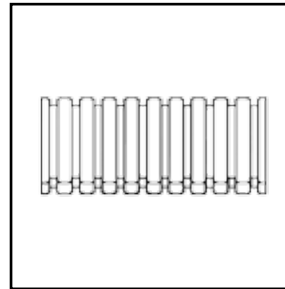

Material:

Poliamida 6 HB

Rango de temperatures:

3000 h: -40°C a 120°C
240 h: -40°C a 150°C

Inflamabilidad:

- UL 94: HB
- a FMVSS 302: <100mm/min

Color(es)/modelos:

- Negro, otras a petición
- Longitudes (montaje en curva ondulado) a petición
- Contenedor a petición

Caraterísticas:

- dos piezas
- con longitud divisible
- con cierre

- caberal distribuidor Schlemmer, con conectores y accesorios multiples usos
- Alta capacidad de resistencia al fria y al desgaste y rotura
- Flexibilidad constante
- Muy buena Resistencia química

Aplicaciones:

- Ideal para montajes posteriores y reparaciones al aire libre
- Como cable en oficinas y empresas privadas de informatica y tecnologia
- Industria Automoción
- Armaria de control
- Fabricación de electrodomésticos
- Calefacción y climatización
- Industria electronica
- Industria naval y ferroviaria
- Construcción de máquinas

Material:

Polyamide 6 HB

Temperature range:

3000 h: -40°C to 120°C
240 h: -40°C to 150°C

Inflamability:

- UL 94: HB
- Acc. to FMVSS 302: <100mm/min

Colour(s)/Designs:

- Black, others on request
- Cutted lengths (cut on the crest) on request
- Containers on request

Characteristics:

- Two piece
- Longitudinal dividable
- Closable

• Schlemmer Manifolds, Conduit Glands and Accessories usable

- High cold impact strength and ultimate elongation
- Bending stabile
- Excellent chemical resistance

Applications:

- Ideal for retrofit and repair
- As cable organizer for office and private sector e.g. Computer, HiFi
- Automotive Industries
- Switch cabinets
- Household Appliances
- Heating and air conditioning
- Electric Power Industry
- Ship- and train building
- Machines

DN	Ø A mm	Ø I mm	Art.-No.	UE m	Precio
NW	Ø A mm	Ø I mm	Art. no	PU m	price
7,5	10,3	5,6	015 129 107	50	
10	13,3	8,5	015 129 110	50	
13	16,0	11,0	015 129 113	50	
17	21,5	15,5	015 129 117	50	
22	25,6	19,1	015 129 122	50	
26	31,7	24,0	015 129 126	25	
29	35,0	27,2	015 129 129	25	
37	42,5	32,0	015 129 137	25	
50	53,9	43,9	015 129 150	25	

a petición
on request

verschließbar - lockable

POLYFLEX®

con cierre



POLYFLEX®

lockable

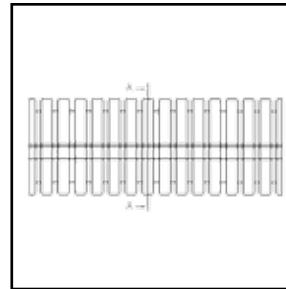

Material:

PPmod:
Polipropileno modificado
Otras materiales a petición

Rango de temperaturas:

PPmod: 3000 h: -40°C a 135°C
PPmod: 500 h: -40°C a 150°C

Inflamabilidad:

- a FMVSS 302: autoextinguible
- escozor tasa 0 a DIN 75200

Color(es)/modelos:

- Negro, otras a petición
- Longitudes y contenedor a petición

Carateristicas:

- Reducción del peso debido al usos de DN más pequeño
- Curvaturas más pequeñas
- No necesita cinta adhesiva para los cables de alimentación y los extremos de los cables
- Resistencia a los rayos ultravioleta (UV) DIN EN ISO 8580
- Posibilidad de cierre automático sólo utilizando el cierre original de Schlemmer

Aplicaciones:

- Coches y camiones pesado
- Compartimentos del motor y puntos cercanos
- Adecuado para montajes posteriores

Material:

PPmod: modified Polypropylene
Further materials on request

Temperature range:

PPmod: 3000 h: -40°C to 135°C
PPmod: 500 h: -40°C to 150°C

Inflammability:

- Acc. to FMVSS 302: selfextinguishing
- Burningrate 0 acc. to DIN 75200

Colour(s)/Designs:

- Black, others on request
- Cutted lengths and Containers on request

Characteristics:

- Reduction in weight by using the smallest NW
- Smallest bending radil
- No wrapping tape necessary at cable feeders or cable ends
- UV resistant acc. to DIN EN ISO 8580
- Process safe locking only by using the original Schlemmer closing tool

Applications:

- Cars and heavy trucks
- Body section and near the engine
- For subsequent assembly

con cierre
Lockable

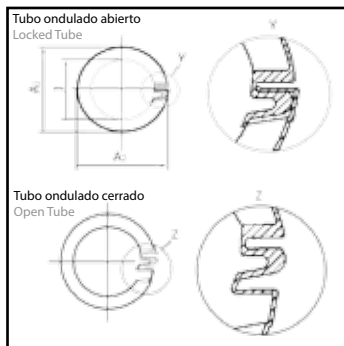

Material	DN	UL 94	Accesorios disponibles	Ø A1 mm	Ø A2 mm	Ø l mm	Art. No.	Precio
Material	NW	UL 94	suitable Accessories	Ø A1 mm	Ø A2 mm	Ø l mm	Art. no.	price
PPmod	8,5V	V2	DN 10	12,8	13,3	8,6	014 147 708	a petición on request
PPmod	11V	V2	DN 13	15,7	16,3	11,2	014 147 711	
PPmod	13V	V2	-	18,3	18,9	12,2	014 147 713	
PPmod	15V	V2	DN 17	21,3	22,0	14,9	014 147 715	
PPmod	19V	V2	DN 22	25,6	26,2	19,0	014 147 719	
PPmod	26V	V2	DN 26	31,5	32,0	24,6	014 147 726	



Otros tipos de tubos especiales corrugados y accesorios, se pueden encontrar en nuestro catálogo de tubos corrugados o online!
Special corrugated tubes and equipment you will find in our product catalogue for corrugated pipes or online!



PROTECCIÓN PARA CABLES

Cable protection

Accesorio accessories

Clipes de apoyos - retaining clip

Clipes de apoyos

retaining clip

negro

black

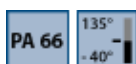

Material:
Poliamida 66

Rango de temperatures:
240 h/150°C

- Características:**
- montaje flexible
 - conexión óptima para tubo ondulado

- Aplicaciones:**
- para la fijación de tubo ondulado o las tasas de línea en carrocerías de automóviles



Material:
Polyamide 66

Top operating temperature:
240 h/150°C

- Characteristics:**
- flexible mountable
 - optimal access for corrugated tubes

- Applications:**
- for fixation of corrugated pipes or cable harness on auto body

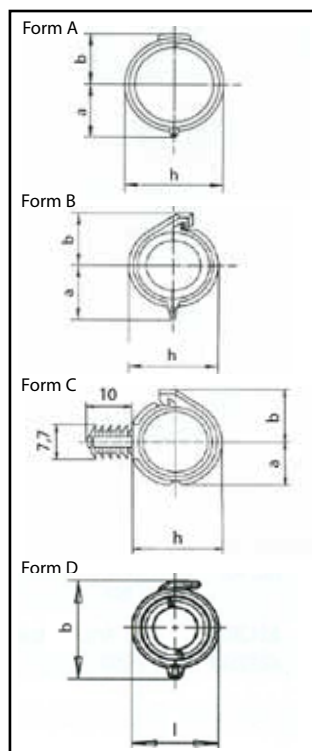

Forma	para DN perfil normale	para DN AHW	h mm	b mm	l mm	Art. No.	UE pezz.	Precio
form	for NW normal profile	for NW AHW	h mm	b mm	l mm	art. no.	PU unit	price
A	4,5	4,5	13,0	9,4	014 200 004	100		
A	7,5	6	15,8	12,2	014 200 007	100		
A	10	8,5	18,9	15,4	014 200 010	100		
A	13	11	21,6	18,3	014 200 013	100		a petición on request
A	14		24,6	21,3	014 200 014	100		
A	17	15	27,1	23,6	014 200 017	100		
A	22	19	31,6	28,3	014 200 022	100		
A	26	26	37,7	34,4	014 200 026	100		
B	8,5		18,3	15,6	014 200 508	100		a petición on request
B	23S				014 200 523	100		
C	4,5	4,5	10,2	5,5	7,2	014 200 604	100	
C	7,5	6	13,2	7,0	8,7	014 200 607	100	
C	8,5		14,7	7,8	9,5	014 200 608	100	
C	10	8,5	15,8	8,3	10,0	014 200 610	100	a petición on request
C	13	11	19,0	10,0	11,7	014 200 613	100	
C	17	15	24,0	12,0	14,0	014 200 617	100	
C	22	19	28,4	14,6	16,2	014 200 622	100	
D	17	15	27,4	23,8		014 200 717	100	a petición on request
D	22	19	31,9	28,3		014 200 722	100	

Brida de sujeción - cable ties

Brida de sujeción

Cable ties

negro

black



Material:
Poliamida 6.6

Rango de temperaturas:
-40°C bis +60°C

Inflamabilidad:
UL 94: V2

Color(es)/modelos:
negro

- Caraterísticas:**
- SKB: brida de sujeción bloqueable
 - Resistente a aceites , gasolina, agua salada , disolventes , álcalis
 - UV estabilizado

Material:
Polyamide 6.6

Temperature range:
-40°C to +60°C

Inflamability:
UL 94: V2

Colour/execution:
black

- Characteristics:**
- SKB: self lock tie
 - Resistant against: Oils, petrols, saltwater, sulfids, alkalis
 - UV-stabilized

Tipo type	Dimensión l x b mm dimensions l x b mm	para max. Ø for max. Ø	min. resistencia a la tracción kg min. tensile strength kg	Art. No. art. no.	Referencia-No. reference no.	UE pezz. PU pcs.	Precio price
SKB 100 x 2,5	100 x 2,5	24,0	11,0	042 025 100	8330200	100	
SKB 200 x 2,5	200 x 2,5	55,0	11,0	042 025 200	8330203	100	
SKB 300 x 4,5	300 x 4,5	82,0	28,0	042 045 300	8330215	100	
SKB 360 x 4,5	360 x 4,5	101,0	28,0	042 045 360	8330216	100	
SKB 430 x 4,5	430 x 4,5	123,0	28,0	042 045 430	8330217	100	
SKB 360 x 7,5	360 x 7,5	101,0	65,0	042 075 360	8330221	100	
SKB 550 x 9,0	550 x 9,0	160,0	80,0	042 090 550	8330225	100	

a petición
on request

Taller equipiamiento

**Este grupo de productos incluye prolongadores de 220/240 V y distribuidor etc.
Nosotros podemos realizar variaciones específicas a petición.**

FACTORY EQUIPMENT

**This product line includes 220/240 V extensions and distributor etc.
We generate and manufacture custom-specific variations.**





230/400 V 230/400 V

Distribuidor trifásico - three-phase current distributor



Distribuidor trifásico IP44 400 V/16A con 1xCEE clavija, 2xCEE toma de enchufe y 1x toma de enchufe Schuko sin garantía.

Three-phase current distributor IP44 400V/16A with 1x CEE-plug, 2x CEE-sockets and 1x Schuko plug socket unsecured.

Art. - No. Art. no.	Precio price
224 435 502	a petición on request

Distribuidor Schuko - Schuko-distributor



Distribuidor de toma de enchufe Schuko IP44 230V/16A con 4 tomas de enchufe y 1 gancho metálico abatible.

Socket distributor IP44 230V/16A with 4x Schuko plug and retractable metal hook.

Art. - No. Art. no.	Precio price
224 065 402	a petición on request

Distribuidor Schuko - Schuko-distributor



Distribuidor de plástico móvil IP44 230V/16A con asa, tornillos 1xM20 y 3 tomas de enchufe Schuko sin garantía.

Mobile plastic distributor IP44 230V/16A with bracket, 1x M20 bolting and 3x Schuko plug socket unsecured.

Art. - No. Art. no.	Longitud length	Precio price
224 045 302	1,5 m	a petición on request

Distribuidor Schuko - Schuko-distributor



Distribuidor con acoplamiento en goma dura IP54 230V con triple tapa abatible y anclaje de seguridad.

Solid rubber-hang up coupling IP54 230V with triple hinged lids and hitch.

Art. - No. Art. no.	Longitud length	Precio price
224 040 302	1,5 m	a petición on request

Clavija Schuko - Schuko-plug



Protección para los contactos de enchufe en goma de color amarillo o rojo 230V/AC, 16A.
 Safety plug gum yellow or red, 230V/AC, 16A.

Art. - No. Art. no.	Color colour		Precio price
224 006 201	amarillo	yellow	a petición on request
224 003 201	rojo	red	

Toma de enchufe Schuko - Schuko-socket



Protección para los contactos de la toma de enchufe en goma de color amarillo o rojo 230V/AC, 16A.
 Safety plug gum yellow or red, 230V/AC, 16A.

Art. - No. Art. no.	Color colour		Precio price
224 006 202	amarillo	yellow	a petición on request
224 003 202	rojo	red	

Cable extensible - extension



Cable de extensión para trabajos de construcción en carretera de 230V con contacto de enchufe en goma de color rojo con carga hasta 3500 Watt.

Road works extension cable 230V with gum-contact plug. Up to 3500 watt resilient.

Art. - No. Art. no.	Longitud length	Corte a través cross-section	Precio price
224 063 151	10 m	3 x 1,5 mm ²	a petición on request
224 063 155	25 m	3 x 1,5 mm ²	
224 063 252	50 m	3 x 1,5 mm ²	

Cable extensible - extension



Cable de extensión de color blanco para trabajos de construcción en carretera de 230V con contacto de enchufe en goma de color blanco con carga hasta 3500 Watt.

Road works extension cable 230V with gum-contact plug. Up to 3500 watt resilient.

Art. - No. Art. no.	Longitud length	Corte a través cross-section	Precio price
224 066 151	10 m	3 x 1,5 mm ²	a petición on request
224 066 155	25 m	3 x 1,5 mm ²	
224 066 252	50 m	3 x 1,5 mm ²	

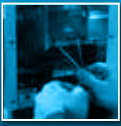

ESQUEMAS ELÉCTRICOS

assignment charts

24 Volt - 7 polos - 24 Volt - 7-pole

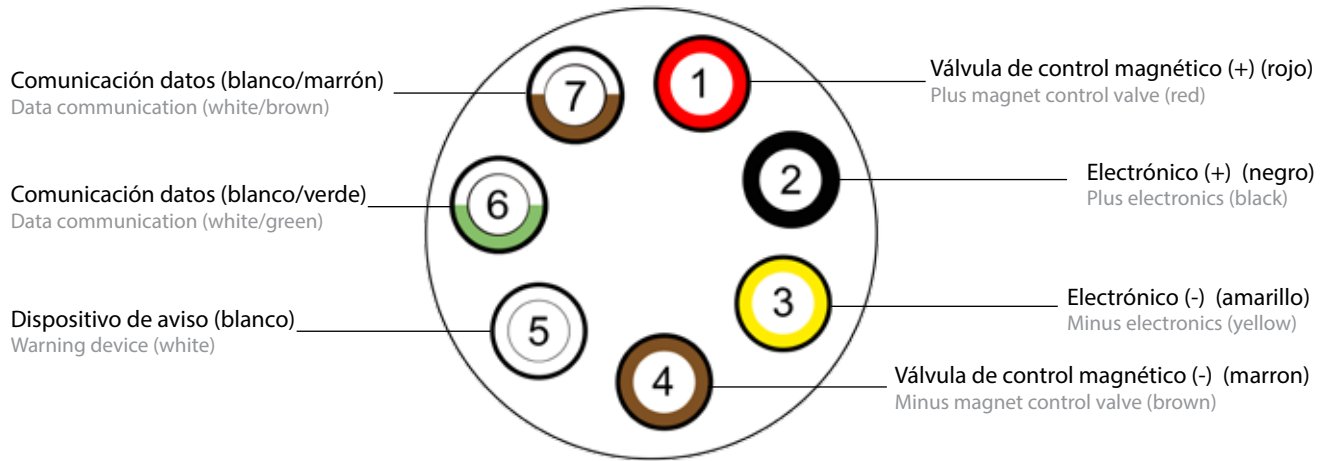

24 Volt - 15 polos - 24 Volt - 15-pole

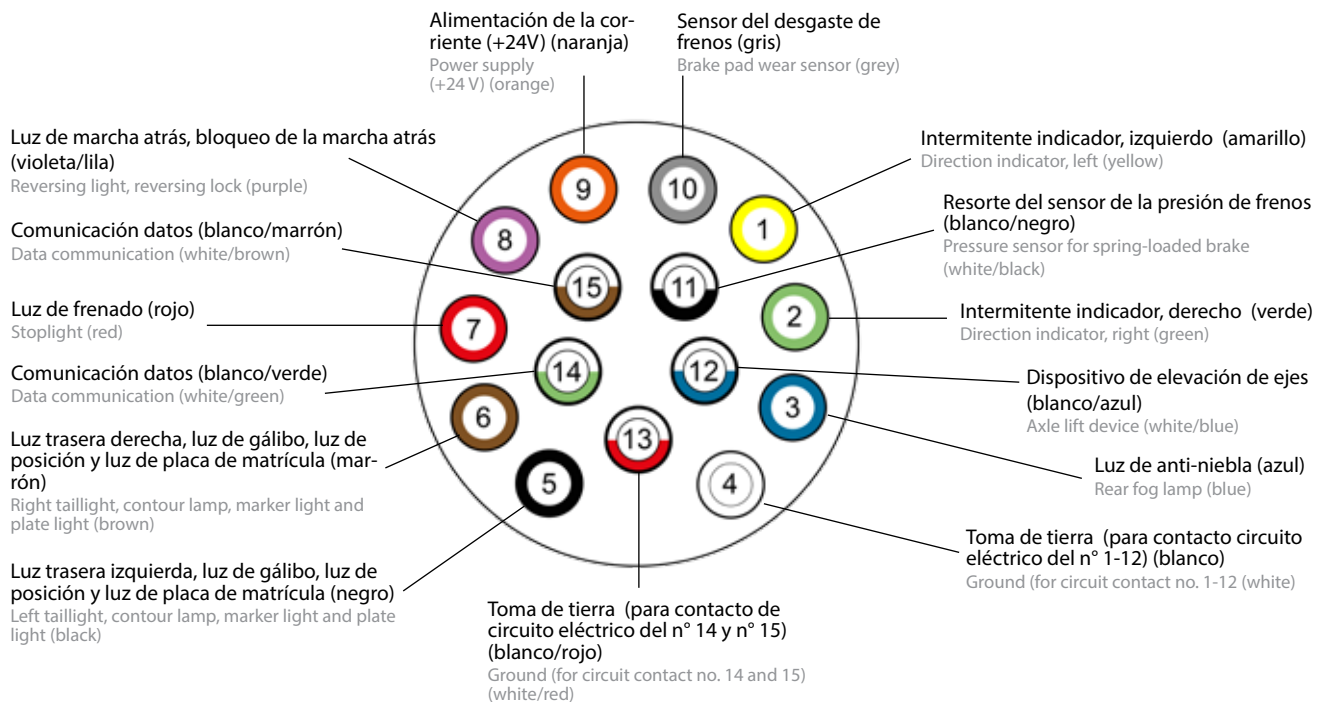

24 Volt - 7 polos Tipo S - 24 Volt - 7-pole type S

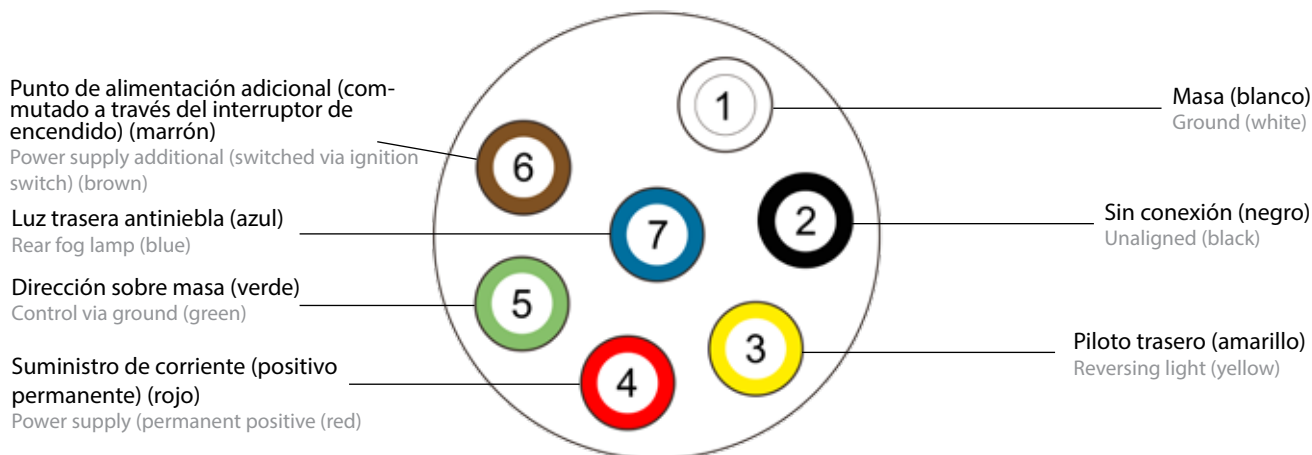

24 Volt - 7 polos Tipo N - 24 Volt - 7-pole type N

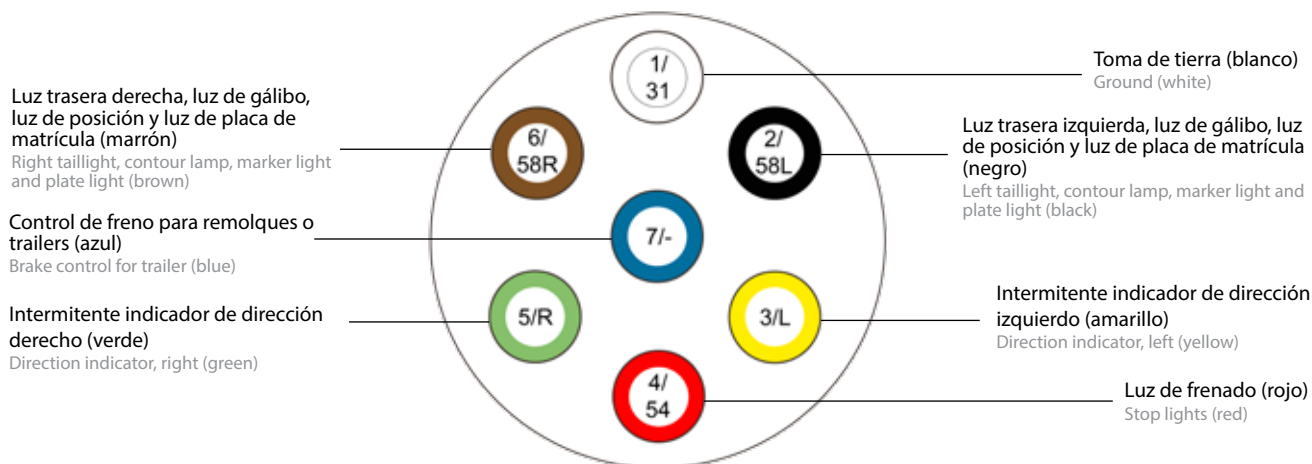

Resumen del Código de Grado de Protección Internacional

Overview of the IP-Code parts

Las categorías de protección se denominan por códigos cortos, los cuales aparecen siempre con un código precedido por las letras PI (Protección Internacional) y dos siguientes dígitos que pertenecen al grado de protección. La primera cifra indica simultáneamente el grado de protección de las personas contra el contacto directo y de los materiales contra la penetración de cuerpos sólidos extraños. La segunda cifra indica el grado de protección con respecto a los efectos perjudiciales sobre el equipo debido a la penetración de agua.

The protection categories are named by a short symbol which are made up of always constant code letters IP (International Protection) and two following code digits for the degree of protection. The first code digit indicates the protection against contact and foreign bodies, the second code digit indicates the degree of protection against the ingress of moisture.

1ª Cifra 1 st key figure	Protección contra contactos directos contra personas protection against contact by persons	Protección contra la penetración de impurezas protection against ingress of solid foreign bodies	2ª Cifra 2 nd key figure	Protección contra la penetración de agua protection against ingress of water
0 0	no protegido unprotected	no protegido unprotected	0 0	non protegido unprotected
1 1	con el dorso de la mano with the back of the hand	objetos con Ø mayor de 50 mm object with Ø over 50 mm	1 1	goteo vertical de agua vertical drop
2 2	con un dedo with the finger	objetos con Ø mayor de 12,5 mm object with Ø over 12,5 mm	2 2	goteo de agua hasta 15° de la vertical drop at 15° inclination
3 3	con una herramienta with tools	objetos con Ø mayor de 2,5 mm object with Ø over 2,5 mm	3 3	rociado con agua hasta 60' de la vertical spray water
4 4	con un alambre with thin conductor	objetos con Ø mayor de 1 mm object with Ø over 1 mm	4 4	rociado con agua en todas las direcciones splash water
5 5	con un alambre with thin conductor	protegido contra el polvo dust-protected	4 K 4 K	rociado con agua bajo un incremento de la presión (sólo para vehículos de carretera) splash water, under increased pressure, only for road vehicle
6 6	completo completely	libre de polvo dust-tight	5 5	chorros de agua en todas las direcciones hose water
			6 6	chorros de agua a presión powerful hose water
			6 K 6 K	Chorros de agua bajo incremento de la presión por inundación (sólo para vehículos por carretera). powerful hose water, under increased pressure (flooding), only for road vehicle
			7 7	inmersión temporal temporarily immersion
			8 8	inmersión permanente permanently immersion
			9 K 9 K	submersión bajo alta presión/sistema limpieza a vapor (sólo para vehículos por carretera). at high pressure-/steam jet cleaning, only for road vehicle

Condiciones legales

Legal notices

Con este catálogo quedan anuladas todas nuestras anteriores ofertas. Un contrato queda cerrado sólo si se confirma la orden de pedido por escrito. Para todos nuestros pedidos aplicamos las condiciones actuales de venta y envío. Nuestro catálogo está exclusivamente disponible para el sector industrial.

Nos reservamos el derecho a cambios o mejoras en nuestros diseños o versiones. Los precios se ajustarán anualmente dependiendo del mercado del metal. Sin embargo, nos reservamos de forma expresa el cambio en los precios en vigor a lo largo del año. No

se garantiza que las fotos sean plenamente acordes al producto. Queda excluida cualquier compensación por errata o datos incompletos en el catálogo.

Cualquier plano, esquema, fotos y documentación técnica como pueden ser muestras, catálogos, folletos, así como también la entrega de estudios y presupuestos de costes, dibujos de esquemas y otros documentos informativos quedan bajo propiedad intelectual e industrial de la empresa accem-Automotive GmbH.

La empresa se reserva todos los derechos sobre los documentos. Sin la

autorización expresa de la empresa no está permitida la reproducción o transmisión total o parcial, por cualquier vía, de los ningún documento. Los productos suministrados tienen como uso normal y exclusivo en destino y solamente pueden ser instalados por personal cualificado.

All our previous offers are invalid with this catalogue. A contract is only closed if we confirm the receipt of the order in written form. For all our deliveries apply the current conditions of sale and delivery. Our catalogue is only ment for the commercial sector.

We reserve the right to improvements and modifications of the building class. The prices will be adjusted annually to the metal quotation. We reserve however the right to change prices during

the calendar year if there are significant changes. We grant no guarantee for the complete accordance of the illustration with the product. Compensations because of eventually misprints or incomplete indications are excluded.

Plans, drafts or other technical documents, samples, catalogues, brochures or illustrations as well as quotations, paintings or other bidding documents stay always intellectual property of the company accem-Automotive GmbH.

We reserve all the rights of the documents. Without our approval it isn't allowed to duplicate or to transmit these documents. Products which are delivered of us are only for normal use and may only be installed of expert staff.



accem - Automotive GmbH

Maderspergerstraße 10
A-4560 Kirchdorf/Krems
Tel. +43 7582 / 61 219 - 0
Fax +43 7582 / 61 219 - 30
E-mail: office@accem.at



accem - Automotive GmbH

Vertriebspartner gesucht
Nous recherchons des distributeurs
Tel. +43 7582 / 61 219 - 0
Fax +43 7582 / 61 219 - 30
E-mail: office@accem.at

Marketing und Entwicklung

Ramsau 29
A-4591 Molln
Tel. +43 7582 / 61 219 - 10
Fax +43 7582 / 61 219 - 30
E-mail: office@accem.at



accem - Automotive GmbH

Vertriebspartner gesucht
Buscando distribuidores
Tel. +43 7582 / 61 219 - 0
Fax +43 7582 / 61 219 - 30
E-mail: office@accem.at



Mazzucchelli S.r.l.

Via Sansovino, 243/65/T
10151 Torino (TO) - Italia
Tel. +39 011 4532064
Fax +39 011 4540930
E-mail: commerciale@maz.it
www.maz.it



accem - Automotive GmbH

Vertriebspartner gesucht
Looking for distribution partner
Tel. +43 7582 / 61 219 - 0
Fax +43 7582 / 61 219 - 30
E-mail: office@accem.at



accem - Automotive GmbH

Vertriebspartner gesucht
Tel. +43 7582 / 61 219 - 0
Fax +43 7582 / 61 219 - 30
E-mail: office@accem.at



accem - Automotive GmbH

Vertriebspartner gesucht
Jälleenmyyjät halusi
Tel. +43 7582 / 61 219 - 0
Fax +43 7582 / 61 219 - 30
E-mail: office@accem.at



accem - Automotive GmbH

Vertriebspartner gesucht
Tel. +43 7582 / 61 219 - 0
Fax +43 7582 / 61 219 - 30
E-mail: office@accem.at



accem - Automotive GmbH

Vertriebspartner gesucht
Distributörer ville
Tel. +43 7582 / 61 219 - 0
Fax +43 7582 / 61 219 - 30
E-mail: office@accem.at